

CE EMC Test Report (EN 50155 & EN 50121-3-2)

Report No.: CE200217D10-1

Test Model: RMS-1100

Series Model: RMS-1XXXXXXXXXX ("X" can be 0-9, A-Z or blank for marketing purpose)

Received Date: Feb. 17, 2020

Test Date: Feb. 21 to Mar. 19, 2020

Issued Date: Mar. 23, 2020

Applicant: Vecow Co., Ltd.

Address: 3F., No.10, Jiankang Rd., Zhonghe Dist., New Taipei City 23586, Taiwan

Issued By: Bureau Veritas Consumer Products Services (H.K.) Ltd., Taoyuan Branch
Lin Kou Laboratories

Lab Address: No. 47-2, 14th Ling, Chia Pau Vil., Lin Kou Dist., New Taipei City, Taiwan



This report is for your exclusive use. Any copying or replication of this report to or for any other person or entity, or use of our name or trademark, is permitted only with our prior written permission. This report sets forth our findings solely with respect to the test samples identified herein. The results set forth in this report are not indicative or representative of the quality or characteristics of the lot from which a test sample was taken or any similar or identical product unless specifically and expressly noted. Our report includes all of the tests requested by you and the results thereof based upon the information that you provided to us. You have 60 days from date of issuance of this report to notify us of any material error or omission caused by our negligence, provided, however, that such notice shall be in writing and shall specifically address the issue you wish to raise. A failure to raise such issue within the prescribed time shall constitute your unqualified acceptance of the completeness of this report, the tests conducted and the correctness of the report contents. Unless specifically mentioned, the uncertainty of measurement has been explicitly taken into account to declare the compliance or non-compliance to the specification. The report must not be used by the client to claim product certification, approval, or endorsement by TAF or any government agencies.

Table of Contents

Release Control Record	4
1 Certificate of Conformity	5
2 Summary of Test Results	6
2.1 Performance Criteria	9
2.2 Measurement Uncertainty	9
2.3 Modification Record	9
3 General Information	10
3.1 Description of EUT	10
3.2 Features of EUT	10
3.3 Operating Modes of EUT and Determination of Worst Case Operating Mode	11
3.4 Test Program Used and Operation Descriptions	12
3.5 Primary Clock Frequencies of Internal Source	12
4 Configuration and Connections with EUT	13
4.1 Connection Diagram of EUT and Peripheral Devices	13
4.2 Configuration of Peripheral Devices and Cable Connections	15
5 Conducted Disturbance at Auxiliary a.c. or d.c. Power Ports	17
5.1 Limits	17
5.2 Test Instruments	17
5.3 Test Arrangement	18
5.4 Test Results	19
6 Radiated Disturbance up to 1 GHz	21
6.1 Limits	21
6.2 Test Instruments	21
6.3 Test Arrangement	22
6.4 Test Results	23
7 Radiated Disturbance above 1 GHz	25
7.1 Limits	25
7.2 Test Instruments	26
7.3 Test Arrangement	27
7.4 Test Results	28
8 Harmonics Current Measurement	30
8.1 Limits	30
8.2 Classification of Equipment	30
8.3 Test Instruments	30
8.4 Test Arrangement	31
8.5 Test Results	31
9 Voltage Fluctuations and Flicker Measurement	32
9.1 Limits	32
9.2 Test Instruments	32
9.3 Test Arrangement	32
9.4 Test Results	33
10 Electrostatic Discharge Immunity Test (ESD)	34
10.1 Test Specification	34
10.2 Test Instruments	34
10.3 Test Arrangement	35
10.4 Test Results	36

11	Radio-frequency Electromagnetic Field Immunity Test (RS)	41
11.1	Test Specification.....	41
11.2	Test Instruments	41
11.3	Test Arrangement	42
11.4	Test Results	43
12	Electrical Fast Transient/Burst Immunity Test (EFT)	44
12.1	Test Specification.....	44
12.2	Test Instruments	44
12.3	Test Arrangement	45
12.4	Test Results	46
13	Surge Immunity Test	47
13.1	Test Specification.....	47
13.2	Test Instruments	47
13.3	Test Arrangement	48
13.4	Test Results	48
14	Immunity to Conducted Disturbances Induced by RF Fields (CS)	49
14.1	Test Specification.....	49
14.2	Test Instruments	50
14.3	Test Arrangement	51
14.4	Test Results	52
15	Pictures of Test Arrangements	53
15.1	Conducted Disturbance at Auxiliary a.c. or d.c. power ports	53
15.2	Radiated Disturbance up to 1 GHz	54
15.3	Radiated Disturbance above 1 GHz	55
15.4	Harmonics Current, Voltage Fluctuations and Flicker Measurement	56
15.5	Electrostatic Discharge Immunity Test (ESD)	56
15.6	Radio-frequency Electromagnetic Field Immunity Test (RS)	57
15.7	Fast Transients (EFT)	58
15.8	Surge.....	60
15.9	Radio-frequency common mode (CS)	61
Appendix – Information of the Testing Laboratories		63

Release Control Record

Issue No.	Description	Date Issued
CE200217D10-1	Original release.	Mar. 23, 2020

1 Certificate of Conformity

Product: RMS-1000 Series rack mount embedded computer

Brand: Vecow

Test Model: RMS-1100

Series Model: RMS-1XXXXXXXXXX ("X" can be 0-9, A-Z or blank for marketing purpose)

Sample Status: Engineering sample

Applicant: Vecow Co., Ltd.

Test Date: Feb. 21 to Mar. 19, 2020

Standards: **EN 50155:2017, Clause 13.4.8**
EN 61000-3-2:2014
EN 61000-3-3:2013
EN 50121-1:2017
EN 50121-3-2:2016
 EN 61000-4-2:2009
 EN 61000-4-3:2006 +A1:2008 +A2:2010
 EN 61000-4-4:2012
 EN 61000-4-5:2014 +A1:2017
 EN 61000-4-6:2014 +AC:2015

The above equipment has been tested by **Bureau Veritas Consumer Products Services (H.K.) Ltd., Taoyuan Branch**, and found compliance with the requirement of the above standards. The test record, data evaluation & Equipment Under Test (EUT) configurations represented herein are true and accurate accounts of the measurements of the sample's EMC characteristics under the conditions specified in this report.

Prepared by :  , **Date:** Mar. 23, 2020
 Jessica Cheng / Senior Specialist

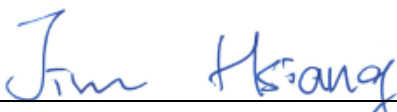
Approved by :  , **Date:** Mar. 23, 2020
 Jim Hsiang / Associate Technical Manager

2 Summary of Test Results

EN 50121-3-2:2016, Emission requirements, EN 50155:2017, Clause 13.4.8			
Port	Test Item / specifications	Result/Remarks	Verdict
Auxiliary a.c. or d.c. power ports - Auxiliary supply sinusoidal a.c. or d.c.	Conducted disturbance 150 kHz- 500 kHz: 99 dB μ V quasi-peak 500 kHz- 30 MHz: 93 dB μ V quasi-peak	Minimum passing margin is -43.70 dB at 1.25781 MHz	Pass
Auxiliary a.c. or d.c. power ports – AC power outlet port for public use	Conducted disturbance 50 Hz- 2 kHz: THD <8% (THD: total harmonic distortion)	Test not applicable because the port does not exist.	N/A
Battery referenced ports - Battery power supply	Conducted disturbance 150 kHz- 500 kHz: 99 dB μ V quasi-peak 500 kHz- 30 MHz: 93 dB μ V quasi-peak	Test not applicable because the port does not exist.	N/A
Enclosure	Radiated disturbance 30 MHz- 230 MHz: 40 dB μ V/m quasi-peak 230 MHz -1 GHz: 47 dB μ V/m quasi-peak	Minimum passing margin is -1.13 dB at 83.99 MHz	Pass
Enclosure	Radiated disturbance 1 GHz- 3 GHz: 76 dB μ V/m peak 56 dB μ V/m average 3 GHz - 6 GHz: 80 dB μ V/m peak 60 dB μ V/m average	Minimum passing margin is -3.71 dB at 1540.09 MHz	Pass

Emission requirements			
Standard	Test Item / specifications	Result/Remarks	Verdict
EN 61000-3-2:2014	Harmonic current emissions	The power consumption of EUT is less than 75W and no limits apply	Pass
EN 61000-3-3:2013	Voltage fluctuations and flicker	$P_{st} \leq 1.0$ $d_{max} \leq 4\%$ $P_{lt} \leq 0.65$ $d_c \leq 3.3\%$ $T_{max} \leq 500ms$	Pass

EN 50121-3-2:2016, Immunity requirements,
EN 50155:2017, Clause 13.4.8

Table Clause	Basic standard	Port	Test Item / specifications	Result/Remarks	Verdict
3.1	EN 61000-4-6:2014 +AC:2015	Battery referenced ports (except at the output of energy sources), Auxiliary a.c. power input ports (rated voltage ≤ 400 Vrms)	Radio-frequency common mode (CS) 80% AM (1kHz) 0.15-80 MHz, 10V Performance Criterion A	Performance Criterion A	Pass
3.2	EN 61000-4-4:2012	Battery referenced ports (except at the output of energy sources), Auxiliary a.c. power input ports (rated voltage ≤ 400 Vrms)	Fast Transients (EFT) 5/50 (T_r/T_h) ns, 5kHz ± 2 kV Performance Criterion A	Performance Criterion A	Pass
3.3	EN 61000-4-5:2014 +A1:2017	Battery referenced ports (except at the output of energy sources), Auxiliary a.c. power input ports (rated voltage ≤ 400 Vrms)	Surges 1.2/50 (8/20) (T_r/T_h) μ s Line to ground: ± 2 kV 42 Ω , 0.5 μ F Line to line: ± 1 kV 42 Ω , 0.5 μ F Performance Criterion B	Performance Criterion A	Pass
4.1	EN 61000-4-6:2014 +AC:2015	Signal & communication, process measurement & control ports	Radio-frequency common mode (CS) 80% AM (1kHz) 0.15-80 MHz, 10V Performance Criterion A	Performance Criterion A	Pass
4.2	EN 61000-4-4:2012	Signal & communication, process measurement & control ports	Fast Transients (EFT) 5/50 (T_r/T_h) ns, 5kHz ± 2 kV, Capacitive clamp Performance Criterion A	Performance Criterion A	Pass
5.1	EN 61000-4-3:2006 +A1:2008 +A2:2010	Enclosure ports	Radio-frequency electromagnetic field amplitude modulated (RS) ¹ , 80% AM (1kHz) 80-800 MHz, 20V/m Performance Criterion A	Performance Criterion A	Pass
5.2	EN 61000-4-3:2006 +A1:2008 +A2:2010	Enclosure ports	Radio-frequency electromagnetic field from digital mobile telephones (RS) ² , 80% AM (1kHz) 800-1000 MHz, 20V/m 1400-2000 MHz, 10V/m 2000-2700 MHz, 5V/m 5100-6000 MHz, 3V/m Performance Criterion A	Performance Criterion A	Pass

EN 50121-3-2:2016, Immunity requirements,
EN 50155:2017, Clause 13.4.8

Table Clause	Basic standard	Port	Test Item / specifications	Result/Remarks	Verdict
5.3	EN 61000-4-2:2009	Enclosure ports	Electrostatic Discharges (ESD) ±6kV Contact discharge ±8kV Air discharge Performance Criterion B	Performance Criterion B	Pass

Note 1: This limit applies to equipment mounted in the passenger compartments, drivers cab or external to the rolling stock (roof, underframe). For equipment mounted in all other areas a severity level of 10 V/m may be used.

Note 2: For large apparatus (e.g. traction drives, auxiliary converters) it is often not practical to perform the immunity test to radiated electromagnetic fields on the complete unit. In such cases the manufacturer should test susceptible sub-systems (e.g. control electronics). The test report should justify the selection or not of sub-systems and any assumptions made (e.g. reduction of field due to case shielding).

Note:

1. There is no deviation to the applied test methods and requirements covered by the scope of this report.
2. The above EN basic standards are applied with latest version if customer has no special requirement.
3. Determining compliance based on the results of the compliance measurement, not taking into account measurement instrumentation uncertainty.
4. N/A: Not Applicable

2.1 Performance Criteria

General Performance Criteria

The general performance criteria apply for those ports for which no specific performance criteria are defined (e.g. auxiliary ports) in the report.

Performance criterion A: The apparatus shall continue to operate as intended during and after the test. No degradation of performance or loss of function is allowed below a performance level specified by the manufacturer, when the apparatus is used as intended. The performance level may be replaced by a permissible loss of performance. If the minimum performance level or the permissible performance loss is not specified by the manufacturer, either of these may be derived from the product description and documentation, and from what the user may reasonably expect from the apparatus if used as intended..

Performance criterion B: The apparatus shall continue to operate as intended after the test. No degradation of performance or loss of function is allowed below a performance level specified by the manufacturer, when the apparatus is used as intended. The performance level may be replaced by a permissible loss of performance. During the test, degradation of performance is however allowed. No change of actual operating state or stored data is allowed. If the minimum performance level or the permissible performance loss is not specified by the manufacturer, either of these may be derived from the product description and documentation, and from what the user may reasonably expect from the apparatus if used as intended.

Performance criterion C: Temporary loss of function is allowed, provided the function is selfrecoverable or can be restored by the operation of the controls.

2.2 Measurement Uncertainty

Where relevant, the following measurement uncertainty levels have been estimated for tests performed on the EUT as specified in CISPR 16-4-2:

Measurement	Expanded Uncertainty (k=2) (\pm)	Maximum allowable uncertainty (\pm)
Conducted disturbance at mains port using AMN, 150kHz ~ 30MHz	3.00 dB	3.4 dB (U_{cispr})
Radiated disturbance, 30MHz ~ 1GHz	4.26 dB	6.3 dB (U_{cispr})
Radiated disturbance, 1GHz ~ 6GHz	4.61 dB	5.2 dB (U_{cispr})

The other instruments specified are routine verified to remain within the calibrated levels, no measurement uncertainty is required to be calculated.

2.3 Modification Record

There were no modifications required for compliance.

3 General Information

3.1 Description of EUT

Product	RMS-1000 Series rack mount embedded computer
Brand	Vecow
Test Model	RMS-1100
Series Model:	RMS-1XXXXXXXXXX ("X" can be 0-9, A-Z or blank for marketing purpose)
Model Difference	For marketing purpose
Sample Status	Engineering sample
Operating Software	Windows 10
Power Supply Rating	DC 24V from adapter
Accessory Device	Adapter
Data Cable Supplied	N/A

Note:

1. The EUT is a RMS-1000 Series rack mount embedded computer with following interfaces:

- | | |
|---|----------------------|
| ◇ COM *2 (RS-232/422/485) | ◇ LAN*2 (10/100Mbps) |
| ◇ USB 3.0*4 | ◇ IGN |
| ◇ Display (resolution up to 4096 x 2304 @ 60Hz) | ◇ M12(LAN) *6 |
| ◇ DVI-I (resolution up to 1920 x 1200 @ 60Hz) | ◇ DC input |
| ◇ Audio out | ◇ GND |
| ◇ Audio in | |

2. The EUT uses following adapter.

Brand	MEAN WELL
Model	GST280A24
Input Power	100-240Vac, 50/60Hz, 4.5A
Output Power	24Vdc, 11.67A, 280.08W
Power Line	Non-shielded AC3-Pin cable (1.8m) Non-shielded DC (1.2m) with one ferrite core

3.2 Features of EUT

1. The tests reported herein were performed according to the method specified by Vecow Co., Ltd., for detailed feature description, please refer to the manufacturer's specifications or user's manual.

2. The EUT was configured with the following key components:

CPU	Intel core i7-8665UE, 1.7GHz
RAM	Innodisk M4S0-4GSSN5IK-H03 DDR4 SO-DIMM 4GB 2666MT/s 512Mx8
SSD	Innodisk DES25-A28M41BW1DC-H03 128GB 2.5" SATA SSD 3ME4, Industrial, W/T Grade

3.3 Operating Modes of EUT and Determination of Worst Case Operating Mode

1. Test modes are presented in the report as below.

Mode	Test Condition	Input Power
Conducted emission test		
1	Full system, Display (3480 x 2160 @ 60Hz) <Note>+ DVI (1920 x 1200 @ 60Hz)	230Vac/ 50Hz
Radiated emission test		
1	Full system, Display (3480 x 2160 @ 60Hz) <Note>+ DVI (1920 x 1200 @ 60Hz)	230Vac/ 50Hz
Harmonics, Flicker, Immunity tests		
1	Full system, Display (3480 x 2160 @ 60Hz) <Note>+ DVI (1920 x 1200 @ 60Hz)	230Vac/ 50Hz

Note: The general maximum resolution of the external display monitor is 3480 x 2160 @ 60Hz.

3.4 Test Program Used and Operation Descriptions

Emission tests:

- a. Turned on the power of all equipment.
- b. EUT ran a test program to enable all functions.
- c. EUT read and wrote messages from/to SSD and ext. HDD.
- d. Notebook PCs (kept in a remote area) sent messages to EUT via two LAN cables (10m each).
- e. Notebook PC (kept in a remote area) sent messages to EUT via Switch Hub with M12 & LAN cables.
- f. EUT sent "H" messages to ext. LCD Monitors. Then they displayed "H" messages on their screens simultaneously.
- g. EUT sent 1kHz audio signal to earphone.
- h. EUT sent messages to printer and printer printed them out.
- i. Steps c-g were repeated.

Immunity tests:

- a. Turned on the power of all equipment.
- b. EUT ran a test program to enable all functions.
- c. EUT read and wrote messages from/to SSD and ext. HDDs.
- d. Notebook PCs (kept in a remote area) sent messages to EUT via two LAN cables (10m each).
- e. Notebook PC (kept in a remote area) sent messages to EUT via Switch Hub with M12 & LAN cables.
- f. EUT sent "H" patterns to ext. LCD Monitors. Then they displayed "H" patterns on their screens simultaneously.
- g. EUT sent 1kHz audio signal to speaker.
- h. Steps c-g were repeated.

3.5 Primary Clock Frequencies of Internal Source

The highest frequency generated or used within the EUT or on which the EUT operates or tunes is 4400MHz, provided by Vecow Co., Ltd., for detailed internal source, please refer to the manufacturer's specifications.

4 Configuration and Connections with EUT

4.1 Connection Diagram of EUT and Peripheral Devices

Emission tests:

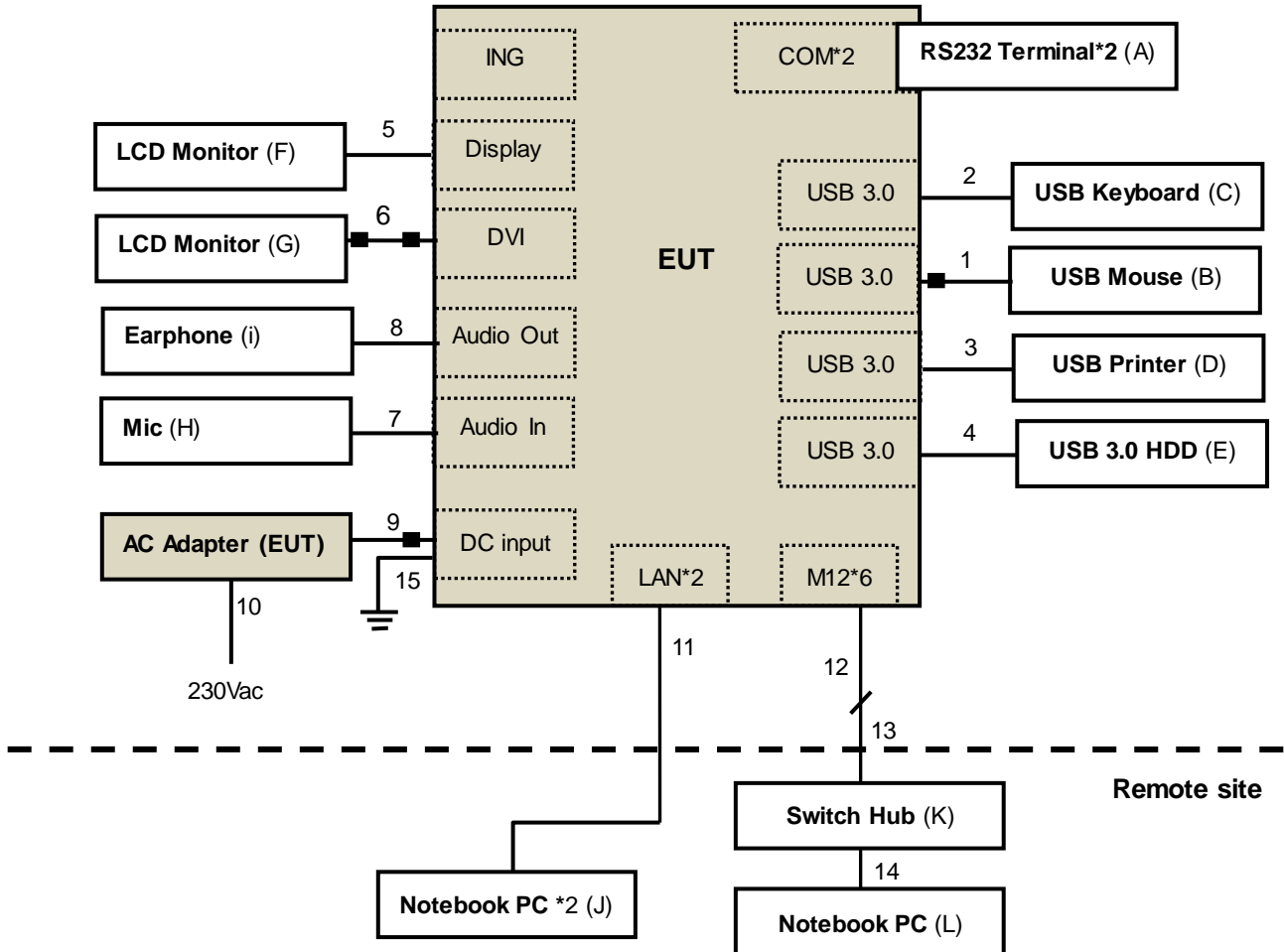

Immunity tests:

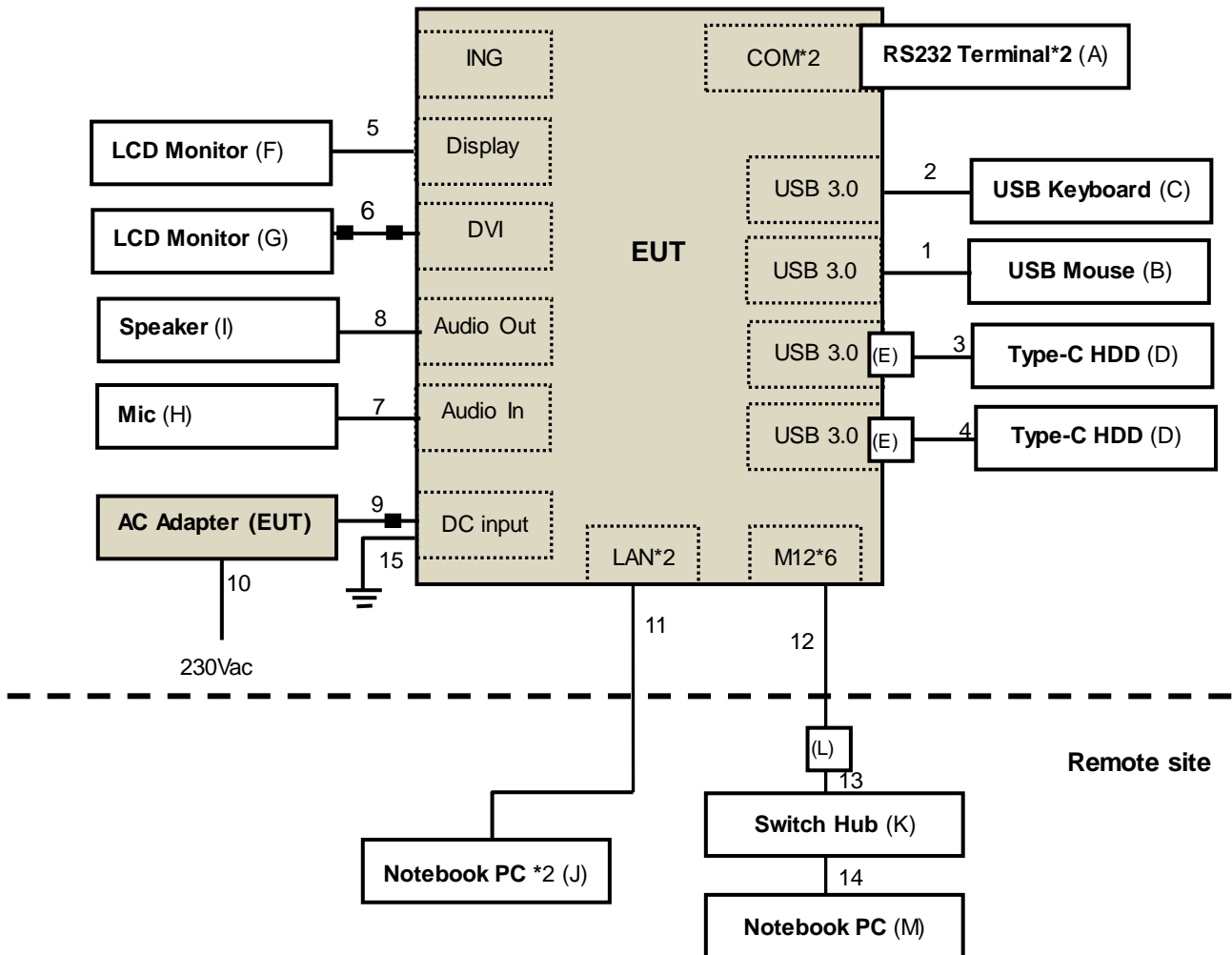

4.2 Configuration of Peripheral Devices and Cable Connections

Emission tests:

ID	Product	Brand	Model No.	Serial No.	FCC ID	Remarks
A.	RS232 Terminal*2	N/A	N/A	N/A	N/A	Supplied by client
B.	USB Mouse	Microsoft	1113	9170528317899	FCC DoC Approved	Provided by Lab
C.	USB KEYBOARD	Dell	KB216t	CN-0W33XP-LO300-7CL-1907	FCC DoC Approved	Provided by Lab
D.	Printer	HP	Officejet pro 251dw	CN55FCV012	B94SDGOB1191	Provided by Lab
E.	USB 3.1 Hard Disk	Transcend	SSD220S	SK21D1718X0057	FCC DoC Approved	Provided by Lab
F.	LCD Monitor	ASUS	MG28UQ	HCLMTF053714	FCC DoC Approved	Provided by Lab
G.	LCD Monitor	DELL	U2410	CN082WXD728720 CC0HLL	FCC DoC Approved	Provided by Lab
H.	MICROPHONE	Labtec	mic-333	N/A	N/A	Provided by Lab
I.	EARPHONE	PHILIPS	SBC HL145	N/A	N/A	Provided by Lab
J.	Notebook PC	DELL	P41G	FT4W952	N/A	Provided by Lab
	Notebook PC	ASUS	PU401L	ECNXBC012528528	N/A	Provided by Lab
K.	Switch Hub	DELL	PowerConnect2608	N/A	N/A	Provided by Lab
L.	Notebook PC	SONY	SVS151A12P	275548477001024	N/A	Provided by Lab

Note:

1. All power cords of the above support units are non-shielded (1.8m).
2. Items J-L acted as communication partners to transfer data.

ID	Cable Descriptions	Qty.	Length (m)	Shielding (Yes/No)	Cores (Qty.)	Remarks
1.	USB cable	1	1.8	Y	1	Provided by Lab
2.	USB cable	1	1.8	Y	0	Provided by Lab
3.	USB cable	1	1.8	Y	0	Provided by Lab
4.	USB A to type-C cable	1	0.5	Y	0	Provided by Lab
5.	Display cable	1	1.8	Y	0	Provided by Lab
6.	DVI cable	1	1.8	Y	2	Provided by Lab
7.	Audio cable	1	2.4	N	0	Provided by Lab
8.	Audio cable	1	1.2	N	0	Provided by Lab
9.	DC power power	1	1.2	N	1	Supplied by client
10.	AC power cord	1	1.8	N	0	Supplied by client
11.	LAN cable	2	10	N	0	Provided by Lab (RJ45, Cat.5e)
12.	M12(LAN) cable	6	1.0	N	0	Supplied by client
13.	LAN cable	1	10	N	0	Provided by Lab
14.	LAN cable	1	3.0	N	0	Provided by Lab
15.	GND	1	1.2	N	0	Provided by Lab

Note: The core(s) is(are) originally attached to the cable(s).

Immunity tests:

ID	Product	Brand	Model No.	Serial No.	FCC ID	Remarks
A.	RS232 Terminal*2	N/A	N/A	N/A	N/A	Supplied by client
B.	USB Mouse	HP	HM01	N/A	N/A	Provided by Lab
C.	USB KEYBOARD	HP	SK-2023	N/A	N/A	Provided by Lab
D.	Type-C HDD	WD	WDBK VX5120PSL	1922MD401110	N/A	Provided by Lab
	Type-C HDD	WD	WDBK VX5120PSL	1922MD400469	N/A	Provided by Lab
E.	Type-C to USB-A*2	N/A	N/A	N/A	N/A	Provided by Lab
F.	24" LCD Monitor	DELL	P2418HZM	CN-079XVV-TV200-8BG-00NT	FCC DoC Approved	Provided by Lab
G.	24" LCD Monitor	DELL	U2412M	CN-07N2FG-TV100-969-02PB	FCC DoC Approved	Provided by Lab
H.	MICROPHONE	N/A	N/A	N/A	N/A	Provided by Lab
I.	SPEAKER	N/A	N/A	N/A	N/A	Provided by Lab
J.	Notebook PC	DELL	P41G	FT4W952	FCC DoC Approved	Provided by Lab
	Notebook PC	ASUS	PU401L	ECNXC012528528	FCC DoC Approved	Provided by Lab
K.	Switch Hub	DELL	PowerConnect2608	N/A	N/A	Provided by Lab
L.	RJ45 connector* 6	N/A	N/A	N/A	N/A	Provided by Lab
M.	Notebook PC	SONY	SVS151A12P	275548477001024	N/A	Provided by Lab

Note:

1. All power cords of the above support units are non-shielded (1.8m).
2. Items J-M acted as communication partners to transfer data.

ID	Cable Descriptions	Qty.	Length (m)	Shielding (Yes/No)	Cores (Qty.)	Remarks
1.	USB cable	1	1.8	Y	0	Provided by Lab
2.	USB cable	1	1.8	Y	0	Provided by Lab
3.	USB-A to Type-C cable	1	0.5	Y	0	Provided by Lab
4.	USB-A to Type-C cable	1	0.5	Y	0	Provided by Lab
5.	Display cable	1	1.8	Y	0	Provided by Lab
6.	DVI cable	1	1.8	Y	2	Provided by Lab
7.	Audio cable	1	2.4	N	0	Provided by Lab
8.	Audio cable	1	1.2	N	0	Provided by Lab
9.	DC power power	1	1.2	N	1	Supplied by client
10.	AC power cord	1	1.8	N	0	Supplied by client
11.	LAN cable	2	10	N	0	Provided by Lab (RJ45, Cat.5e)
12.	M12(LAN) cable	6	1.0	N	0	Supplied by client
13.	LAN cable	6	10	N	0	Provided by Lab (RJ45, Cat.5e)
14.	LAN cable	1	10	N	0	Provided by Lab (RJ45, Cat.5e)
15.	GND	1	1.2	N	0	Provided by Lab

Note: The core(s) is(are) originally attached to the cable(s).

5 Conducted Disturbance at Auxiliary a.c. or d.c. Power Ports

5.1 Limits

Frequency (MHz)	Quasi-peak, (dBuV)
0.15 - 0.5	99
0.5 - 30	93

- Notes: 1. The lower limit shall apply at the transition frequencies.
 2. The limit decreases linearly with the logarithm of the frequency in the range of 0.15 to 0.50 MHz.

5.2 Test Instruments

Description & Manufacturer	Model No.	Serial No.	Cal. Date	Cal. Due
ROHDE & SCHWARZ TEST RECEIVER	ESCS 30	838251/021	Oct. 30, 2019	Oct. 29, 2020
ROHDE & SCHWARZ Artificial Mains Network (For EUT)	ENV216	101195	May 9, 2019	May 8, 2020
LISN With Adapter (for EUT)	101195	N/A	May 9, 2019	May 8, 2020
EMCO L.I.S.N. (For peripherals)	3825/2	9504-2359	Jul. 31, 2019	Jul. 30, 2020
SCHWARZBECK Artificial Mains Network (For EUT)	NNLK8129	8129229	May 14, 2019	May 13, 2020
SCHWARZBECK Artificial Mains Network (For EUT)	NNLK 8121	8121-808	Mar. 15, 2019	Mar. 14, 2020
Software	Cond_V7.3.7.4	NA	NA	NA
RF cable (JYEBAO) With 10dB PAD	5D-FB	Cable-C03-01	Sep. 17, 2019	Sep. 16, 2020
LYNICS Terminator (For EMCO LISN)	0900510	E1-01-300	Jan. 20, 2020	Jan. 19, 2021
LYNICS Terminator (For EMCO LISN)	0900510	E1-01-301	Jan. 20, 2020	Jan. 19, 2021
ROHDE & SCHWARZ Artificial Mains Network (For TV EUT)	ENV216	101196	Apr. 16, 2019	Apr. 15, 2020
LISN With Adapter (for TV EUT)	101196	NA	Apr. 16, 2019	Apr. 15, 2020

- Note: 1. The calibration interval of the above test instruments is 12 months and the calibrations are traceable to NML/ROC and NIST/USA.
 2. The test was performed in Shielded Room No. 3.
 3. The VCCI Site Registration No. C-10274.
 4. Tested Date: Feb. 21, 2020

5.3 Test Arrangement

- The EUT was placed 0.4 meters from the conducting wall of the shielded room with EUT being connected to the power mains through a line impedance stabilization network (LISN). Other support units were connected to the power mains through another LISN. The two LISNs provide 50 Ohm/ 50uH of coupling impedance for the measuring instrument.
- Both lines of the power mains connected to the EUT were checked for maximum conducted interference.
- The test results of conducted emissions at mains ports are recorded of six worst margins for quasi-peak (mandatory) [and average (if necessary)] values against the limits at frequencies of interest unless the margin is 20 dB or greater.

Note: The resolution bandwidth and video bandwidth of test receiver is 9kHz for quasi-peak detection (QP) and average detection (AV) at frequency 0.15MHz-30MHz.

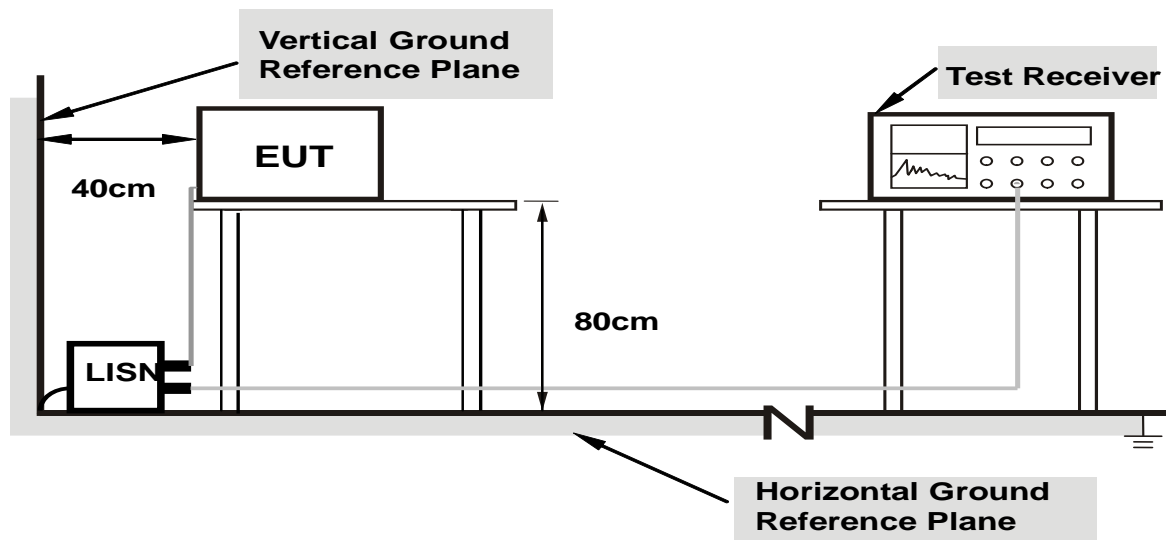

Note: Support units were connected to second LISN.

For the actual test configuration, please refer to the related item – Photographs of the Test Configuration.

5.4 Test Results

Frequency Range	150kHz ~ 30MHz	Detector Function & Bandwidth	Quasi-Peak (QP), 9kHz
Input Power	230Vac, 50Hz	Environmental Conditions	25°C, 70%RH
Tested by	Vhenson Huang		
Test Mode	Mode 1		

Phase Of Power : Line (L)						
No	Frequency (MHz)	Correction Factor (dB)	Reading Value (dBuV)	Emission Level (dBuV)	Limit (dBuV)	Margin (dB)
			Q.P.	Q.P.	Q.P.	Q.P.
1	0.23203	9.61	24.45	34.06	99.00	-64.94
2	0.46641	9.63	25.49	35.12	99.00	-63.88
3	0.74629	9.65	28.09	37.74	93.00	-55.26
4	1.25781	9.68	39.62	49.30	93.00	-43.70
5	2.18750	9.72	22.59	32.31	93.00	-60.69
6	9.83203	9.82	35.35	45.17	93.00	-47.83

Remarks:

1. Q.P. and AV. are abbreviations of quasi-peak and average individually.
2. The emission levels of other frequencies were very low against the limit.
3. Margin value = Emission level – Limit value
4. Correction factor = Insertion loss + Cable loss
5. Emission Level = Correction Factor + Reading Value

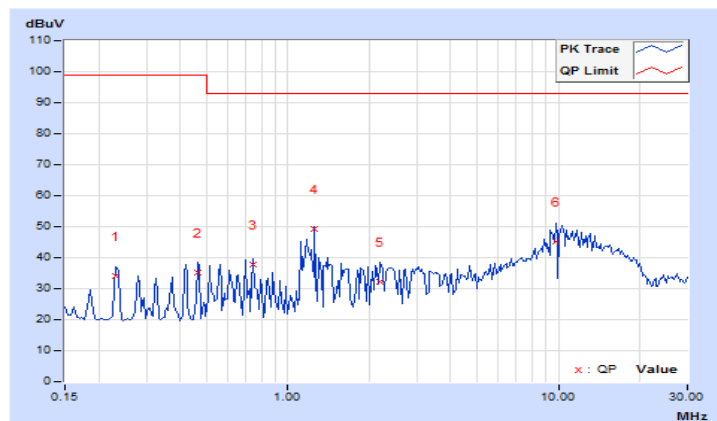

Frequency Range	150kHz ~ 30MHz	Detector Function & Bandwidth	Quasi-Peak (QP), 9kHz
Input Power	230Vac, 50Hz	Environmental Conditions	25°C, 70%RH
Tested by	Vhenson Huang		
Test Mode	Mode 1		

Phase Of Power : Neutral (N)						
No	Frequency (MHz)	Correction Factor (dB)	Reading Value (dBuV)	Emission Level (dBuV)	Limit (dBuV)	Margin (dB)
			Q.P.	Q.P.	Q.P.	Q.P.
1	0.23331	9.60	24.93	34.53	99.00	-64.47
2	0.46641	9.61	25.03	34.64	99.00	-64.36
3	1.25909	9.66	39.28	48.94	93.00	-44.06
4	3.63672	9.73	21.95	31.68	93.00	-61.32
5	8.04297	9.79	35.02	44.81	93.00	-48.19
6	10.76953	9.83	33.44	43.27	93.00	-49.73

Remarks:

1. Q.P. and AV. are abbreviations of quasi-peak and average individually.
2. The emission levels of other frequencies were very low against the limit.
3. Margin value = Emission level – Limit value
4. Correction factor = Insertion loss + Cable loss
5. Emission Level = Correction Factor + Reading Value

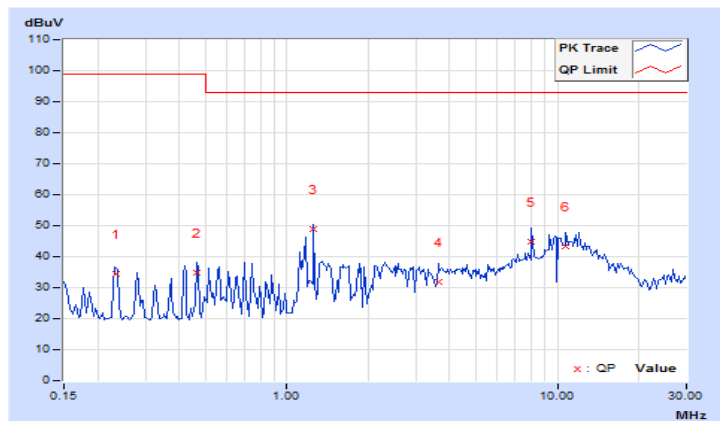

6 Radiated Disturbance up to 1 GHz

6.1 Limits

Frequency (MHz)	dBuV/m (at 10m) / quasi-peak
30 - 230	40
230 - 1000	47

- Notes:
1. The lower limit shall apply at the transition frequencies.
 2. Emission level (dBuV/m) = 20 log Emission level (uV/m).
 3. All emanations from a class A/B digital device or system, including any network of conductors and apparatus connected thereto, shall not exceed the level of field strengths specified above.

6.2 Test Instruments

Description & Manufacturer	Model No.	Serial No.	Cal. Date	Cal. Due
ROHDE & SCHWARZ TEST RECEIVER	ESCI	100744	May 9, 2019	May 8, 2020
Schaffner BILOG Antenna	CBL6111D	22270	Nov. 12, 2019	Nov. 11, 2020
Sonoma Preamplifier	310N	352921	Feb. 18, 2020	Feb. 17, 2021
CT Turn Table	TT100	CT-080	NA	NA
CT Tower	AT100	CT-080	NA	NA
Software	Radiated_V7.6.15.9.5	NA	NA	NA
ANRITSU RF Switches	MP59B	NA	Mar. 6, 2019	Mar. 5, 2020
WOKEN RF cable With 5dB PAD	8D	CABLE-ST3-01	Mar. 6, 2019	Mar. 5, 2020

- Note:
1. The calibration interval of the above test instruments is 12 months and the calibrations are traceable to NML/ROC and NIST/USA.
 2. The test was performed in Open Site No. 3.
 3. The VCCI Site Registration No. is R-269.
 4. Tested Date: Feb. 24, 2020

6.3 Test Arrangement

- The EUT was placed on the top of a rotating table 0.8 meters above the ground at an accredited test facility. The table was rotated 360 degrees to determine the position of the highest radiation.
- The EUT was set 10 meters away from the interference-receiving antenna, which was mounted on the top of a variable-height antenna tower.
- The antenna is a broadband antenna, and its height is varied from one meter to four meters above the ground to determine the maximum value of the field strength. Both horizontal and vertical polarizations of the antenna are set to make the measurement.
- For each suspected emission, the EUT was arranged to its worst case and then the antenna was tuned to heights from 1 meter to 4 meters and the rotatable table was turned from 0 degrees to 360 degrees to find the maximum reading.
- The test-receiver system was set to quasi-peak detect function and specified bandwidth with maximum hold mode when the test frequency is up to 1 GHz.

Note: The resolution bandwidth and video bandwidth of test receiver/spectrum analyzer is 120kHz for quasi-peak detection (QP) at frequency up to 1GHz.

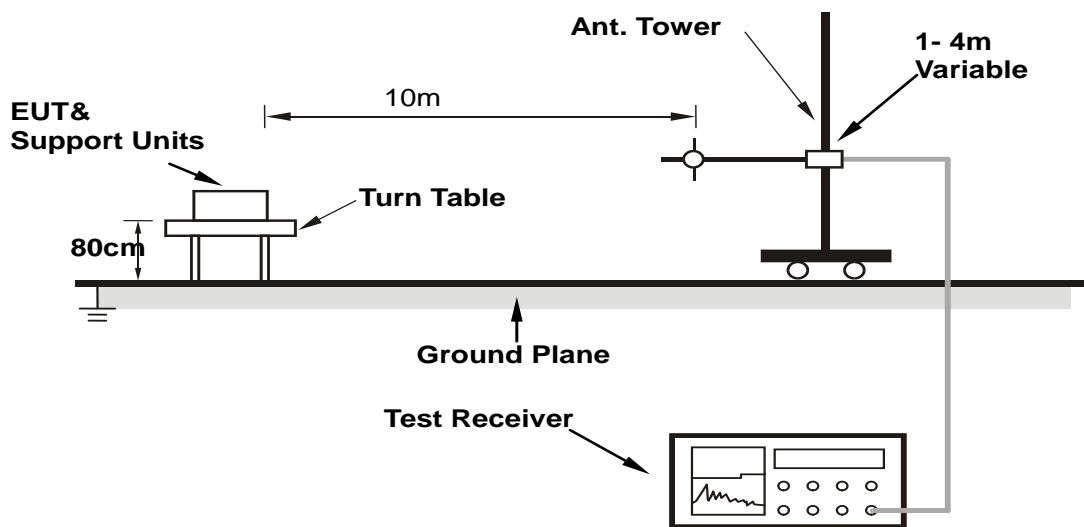

For the actual test configuration, please refer to the related item – Photographs of the Test Configuration.

6.4 Test Results

Frequency Range	30MHz ~ 1GHz	Detector Function & Bandwidth	Quasi-Peak (QP), 120kHz
Input Power	230Vac, 50Hz	Environmental Conditions	25°C, 60%RH
Tested by	Vhenson Huang		
Test Mode	Mode 1		

Antenna Polarity & Test Distance : Horizontal at 10 m

No	Frequency (MHz)	Emission Level (dBuV/m)	Limit (dBuV/m)	Margin (dB)	Antenna Height (m)	Table Angle (Degree)	Raw Value (dBuV)	Correction Factor (dB/m)
1	57.38	28.30 QP	40.00	-11.70	4.00 H	182	49.17	-20.87
2	74.85	31.48 QP	40.00	-8.52	4.00 H	187	51.03	-19.55
3	84.57	33.74 QP	40.00	-6.26	4.00 H	173	52.03	-18.29
4	113.48	30.19 QP	40.00	-9.81	4.00 H	120	44.71	-14.52
5	184.42	33.32 QP	40.00	-6.68	4.00 H	127	49.54	-16.22
6	209.87	30.52 QP	40.00	-9.48	4.00 H	173	46.60	-16.08
7	250.01	38.87 QP	47.00	-8.13	3.44 H	170	50.98	-12.11
8	462.01	41.08 QP	47.00	-5.92	1.81 H	81	47.45	-6.37
9	616.02	41.88 QP	47.00	-5.12	1.50 H	164	44.64	-2.76
10	924.00	44.97 QP	47.00	-2.03	1.16 H	165	42.55	2.42
11	992.44	41.39 QP	47.00	-5.61	1.00 H	112	37.58	3.81

Remarks:

1. Emission Level(dBuV/m) = Raw Value(dBuV) + Correction Factor(dB/m)
2. Correction Factor(dB/m) = Antenna Factor (dB/m) + Cable Factor (dB)
– Pre-Amplifier Factor (dB)
3. The other emission levels were very low against the limit.
4. Margin value = Emission level – Limit value

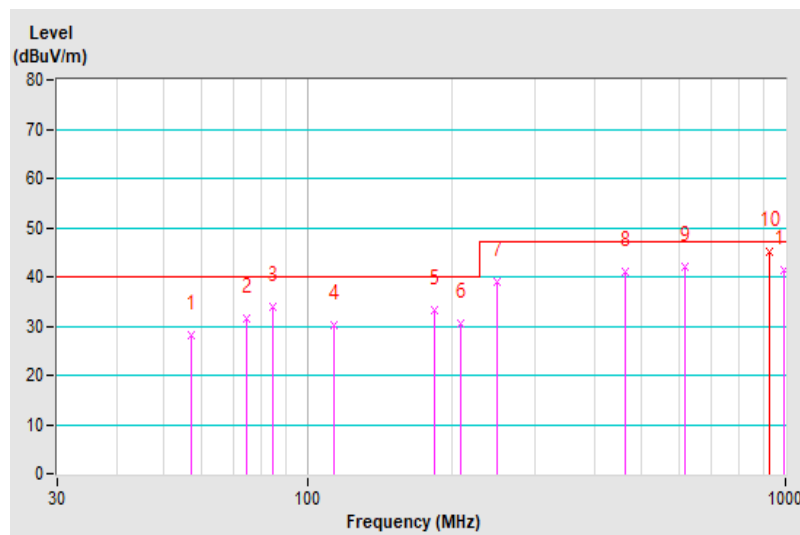

Frequency Range	30MHz ~ 1GHz	Detector Function & Bandwidth	Quasi-Peak (QP), 120kHz
Input Power	230Vac, 50Hz	Environmental Conditions	25°C, 60%RH
Tested by	Vhenson Huang		
Test Mode	Mode 1		

Antenna Polarity & Test Distance : Vertical at 10 m								
No	Frequency (MHz)	Emission Level (dBuV/m)	Limit (dBuV/m)	Margin (dB)	Antenna Height (m)	Table Angle (Degree)	Raw Value (dBuV)	Correction Factor (dB/m)
1	35.37	33.02 QP	40.00	-6.98	1.34 V	113	44.44	-11.42
2	42.47	34.15 QP	40.00	-5.85	1.04 V	181	49.52	-15.37
3	57.70	34.19 QP	40.00	-5.81	1.00 V	42	55.12	-20.93
4	83.99	38.87 QP	40.00	-1.13	1.55 V	345	57.23	-18.36
5	100.31	35.41 QP	40.00	-4.59	1.55 V	132	51.32	-15.91
6	133.72	33.15 QP	40.00	-6.85	1.00 V	284	46.90	-13.75
7	154.03	33.75 QP	40.00	-6.25	1.00 V	118	48.07	-14.32
8	166.10	33.46 QP	40.00	-6.54	1.00 V	233	48.61	-15.15
9	198.49	36.18 QP	40.00	-3.82	1.00 V	180	52.24	-16.06
10	215.31	35.63 QP	40.00	-4.37	1.00 V	99	51.49	-15.86
11	250.01	41.64 QP	47.00	-5.36	1.00 V	325	53.75	-12.11
12	462.00	42.20 QP	47.00	-4.80	3.03 V	143	48.57	-6.37
13	615.98	41.37 QP	47.00	-5.63	3.18 V	60	44.13	-2.76
14	923.99	44.11 QP	47.00	-2.89	2.18 V	323	41.69	2.42
15	992.44	42.47 QP	47.00	-4.53	2.23 V	189	38.66	3.81

Remarks:

1. Emission Level(dBuV/m) = Raw Value(dBuV) + Correction Factor(dB/m)
2. Correction Factor(dB/m) = Antenna Factor (dB/m) + Cable Factor (dB) – Pre-Amplifier Factor (dB)
3. The other emission levels were very low against the limit.
4. Margin value = Emission level – Limit value

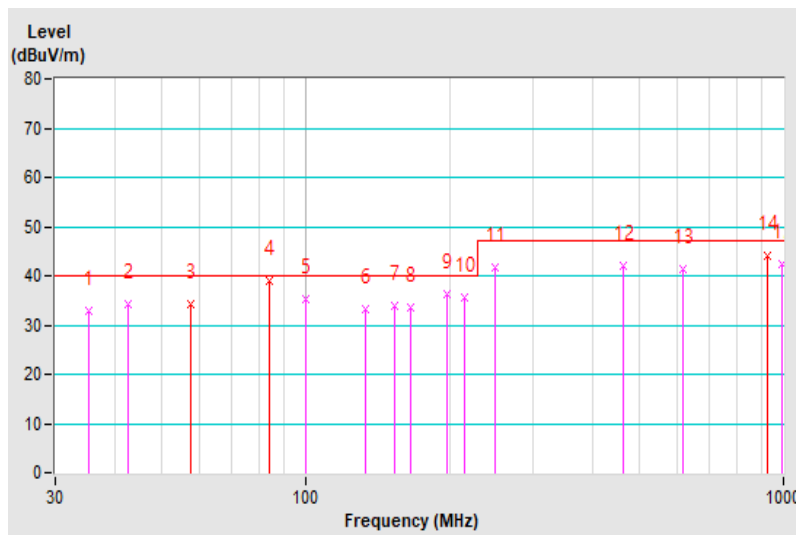

7 Radiated Disturbance above 1 GHz

7.1 Limits

Frequency (GHz)	dBuV/m (at 3m)	
	Average	Peak
1 to 3	56	76
3 to 6	60	80

- Notes:
1. The lower limit shall apply at the transition frequencies.
 2. Emission level (dBuV/m) = 20 log Emission level (uV/m).
 3. All emanations from a class A/B digital device or system, including any network of conductors and apparatus connected thereto, shall not exceed the level of field strengths specified above.

Frequency Range (For unintentional radiators)

Highest frequency generated or used in the EUT or on which the EUT operates or tunes (MHz)	Upper frequency of measurement range (MHz)
Below 108	1000
108-500	2000
500-1000	5000
Above 1000	Up to 5 times of the highest frequency or 6 GHz, whichever is less

7.2 Test Instruments

Description & Manufacturer	Model No.	Serial No.	Cal. Date	Cal. Due
Agilent Spectrum	E4446A	MY51100009	Jun. 6, 2019	Jun. 5, 2020
Agilent Test Receiver	N9038A	MY51210137	Jun. 6, 2019	Jun. 5, 2020
Agilent Preamplifier	8449B	3008A01292	Feb. 20, 2020	Feb. 19, 2021
MITEQ Preamplifier	AMF-6F-260400-33-8P	892164	Feb. 20, 2020	Feb. 19, 2021
EMCI Preamplifier	EMC184045B	980235	Feb. 20, 2020	Feb. 19, 2021
ETS Preamplifier	3117-PA	00215857	Nov. 24, 2019	Nov. 23, 2020
Schwarzbeck Horn Antenna	BBHA-9170	212	Nov. 24, 2019	Nov. 23, 2020
EMCO Horn Antenna	3115	6714	Nov. 24, 2019	Nov. 23, 2020
Max Full. Turn Table	MF7802	MF780208216	NA	NA
Software	Radiated_V8.7.08	NA	NA	NA
KIK + WOKEN RF cable With 3/4dB PAD	K1K50-UP0279-K1K50 -3000+W/C01	Cable-CH10(3m) -04 +Cable-CH10-03	Jul. 10, 2019	Jul. 9, 2020
MICRO-TRONICS Notch filter	BRC50703-01	010	May 30, 2019	May 29, 2020
MICRO-TRONICS Band Pass Filter	BRM17690	005	May 30, 2019	May 29, 2020

- Note:
1. The calibration interval of the above test instruments is 12 months and the calibrations are traceable to NML/ROC and NIST/USA.
 2. The 3dB beamwidth of the horn antenna is minimum 41degree (or $w = 2.24m$ at 3m distance) for 1~6 GHz.
 3. The test was performed in Chamber No. 10.
 4. The VCCI Site Registration No. G-10427
 5. Tested Date: Feb. 24, 2020

7.3 Test Arrangement

- The EUT was placed on the top of a rotating table 0.8 meters above the ground at an accredited chamber room. The table was rotated 360 degrees to determine the position of the highest radiation.
- The EUT was set 3 meters away from the interference-receiving antenna, which was mounted on the top of a variable-height antenna tower.
- The height of antenna can be varied from one meter to four meters, the height of adjustment depends on the EUT height and the antenna 3dB beamwidth both, to detect the maximum value of the field strength. Both horizontal and vertical polarizations of the antenna are set to make the measurement.
- For each suspected emission, the EUT was arranged to its worst case and then the antenna was tuned to heights and the rotatable table was turned from 0 degrees to 360 degrees to find the maximum reading.
- The spectrum analyzer system was set to peak and average detect function and specified bandwidth with maximum hold mode when the test frequency is above 1 GHz.

Note: The resolution bandwidth of test receiver/spectrum analyzer is 1MHz and video bandwidth is 3MHz for Peak detection (PK) at frequency above 1GHz. The resolution bandwidth of test receiver/spectrum analyzer is 1 MHz for Average detection (AV) at frequency above 1GHz.

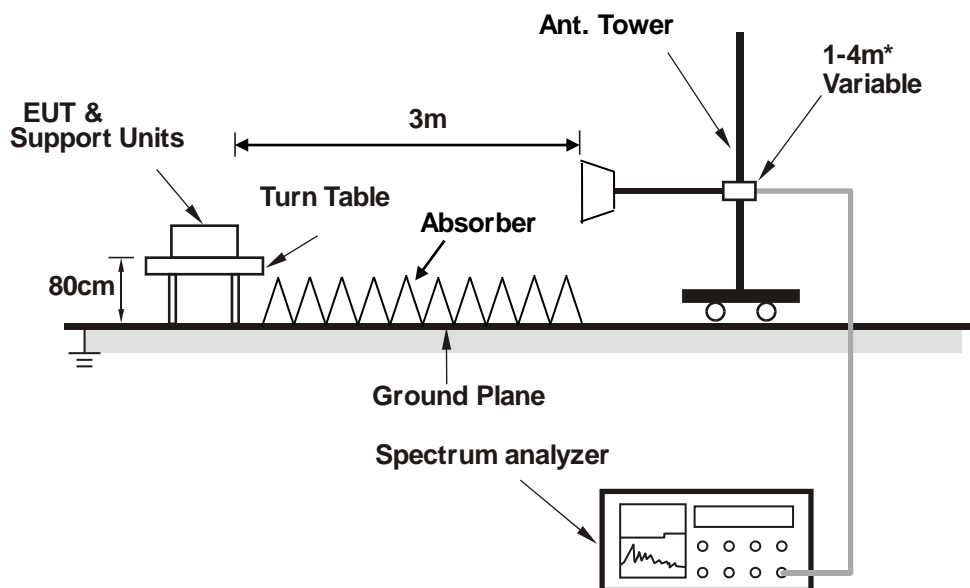

* :depends on the EUT height and the antenna 3dB beamwidth both.

For the actual test configuration, please refer to the related item – Photographs of the Test Configuration.

7.4 Test Results

Frequency Range	1GHz ~ 6GHz	Detector Function & Bandwidth	Peak (PK) / Average (AV), 1MHz
Input Power	230Vac, 50Hz	Environmental Conditions	23°C, 65%RH
Tested by	Paul Chen		
Test Mode	Mode 1		

Antenna Polarity & Test Distance : Horizontal at 3 m

No	Frequency (MHz)	Emission Level (dBuV/m)	Limit (dBuV/m)	Margin (dB)	Antenna Height (m)	Table Angle (Degree)	Raw Value (dBuV)	Correction Factor (dB/m)
1	1232.04	60.88 PK	76.00	-15.12	2.12 H	114	64.60	-3.72
2	1232.04	47.54 AV	56.00	-8.46	2.12 H	114	51.26	-3.72
3	1540.04	62.07 PK	76.00	-13.93	2.35 H	122	64.60	-2.53
4	1540.04	51.94 AV	56.00	-4.06	2.35 H	122	54.47	-2.53
5	2940.54	61.16 PK	76.00	-14.84	2.21 H	117	59.69	1.47
6	2940.54	43.33 AV	56.00	-12.67	2.21 H	117	41.86	1.47

Remarks:

1. Emission Level(dBuV/m) = Raw Value(dBuV) + Correction Factor(dB/m)
2. Correction Factor(dB/m) = Antenna Factor (dB/m) + Cable Factor (dB) – Pre-Amplifier Factor (dB)
3. The other emission levels were very low against the limit.
4. Margin value = Emission level – Limit value

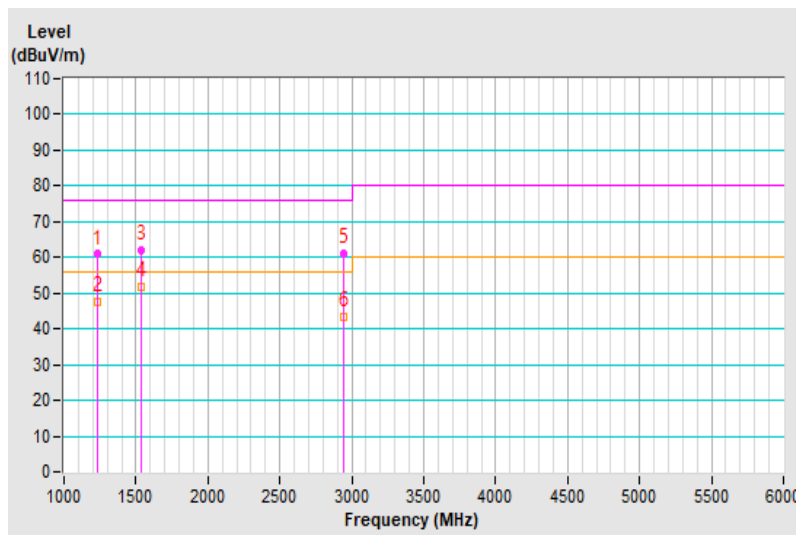

Frequency Range	1GHz ~ 6GHz	Detector Function & Bandwidth	Peak (PK) / Average (AV), 1MHz
Input Power	230Vac, 50Hz	Environmental Conditions	23°C, 65%RH
Tested by	Paul Chen		
Test Mode	Mode 1		

Antenna Polarity & Test Distance : Vertical at 3 m								
No	Frequency (MHz)	Emission Level (dBuV/m)	Limit (dBuV/m)	Margin (dB)	Antenna Height (m)	Table Angle (Degree)	Raw Value (dBuV)	Correction Factor (dB/m)
1	1231.93	64.87 PK	76.00	-11.13	1.25 V	142	68.59	-3.72
2	1231.93	51.23 AV	56.00	-4.77	1.25 V	142	54.95	-3.72
3	1540.09	61.41 PK	76.00	-14.59	2.14 V	208	63.94	-2.53
4	1540.09	52.29 AV	56.00	-3.71	2.14 V	208	54.82	-2.53
5	2942.94	62.42 PK	76.00	-13.58	1.66 V	105	60.93	1.49
6	2942.94	44.25 AV	56.00	-11.75	1.66 V	105	42.76	1.49

Remarks:

1. Emission Level(dBuV/m) = Raw Value(dBuV) + Correction Factor(dB/m)
2. Correction Factor(dB/m) = Antenna Factor (dB/m) + Cable Factor (dB) – Pre-Amplifier Factor (dB)
3. The other emission levels were very low against the limit.
4. Margin value = Emission level – Limit value

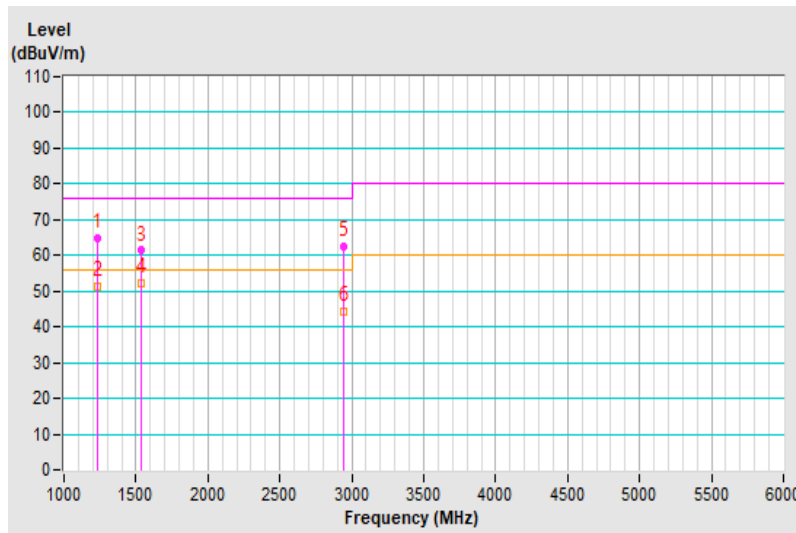

8 Harmonics Current Measurement

8.1 Limits

Limits for Class A equipment		Limits for Class D equipment		
Harmonic Order n	Max. permissible harmonics current A	Harmonic Order n	Max. permissible harmonics current per watt mA/W	Max. permissible harmonics current A
Odd harmonics		Odd Harmonics only		
3	2.30	3	3.4	2.30
5	1.14	5	1.9	1.14
7	0.77	7	1.0	0.77
9	0.40	9	0.5	0.40
11	0.33	11	0.35	0.33
13	0.21	13	0.30	0.21
15 ≤ n ≤ 39	0.15 x 15/n	15 ≤ n ≤ 39	3.85/n	0.15 x 15/n
Even harmonics				
2	1.08			
4	0.43			
6	0.30			
8 ≤ n ≤ 40	0.23 x 8/n			

- Notes: 1. Class A and Class D are classified according to section 5 of EN 61000-3-2.
 2. According to section 7 of EN 61000-3-2, the above limits for all equipment except for lighting equipment having an active input power > 75 W and no limits apply for equipment with an active input power up to and including 75 W.

8.2 Classification of Equipment

Class A	Class B	Class C	Class D
Balanced three-phase equipment; Household appliances excluding equipment as Class D; Tools excluding portable tools; Dimmers for incandescent lamps; Audio equipment; Equipment not specified in one of the three other classes.	Portable tools; Arc welding equipment which is not professional equipment.	Lighting equipment.	Equipment having a specified power less than or equal to 600 W of the following types: Personal computers and personal computer monitors; Television receivers; Refrigerators and freezers having one or more variable-speed drives to control compressor motor(s).

8.3 Test Instruments

Description & Manufacturer	Model No.	Serial No.	Cal. Date	Cal. Due
Teseq Harmonics - Flicker Test System	Proflin 2105	32A00983 & 1639A01863	Sep. 17, 2019	Sep. 16, 2020
Software	CTS 4	NA	NA	NA

- Note: 1. The calibration interval of the above test instruments is 12 months and the calibrations are traceable to NML/ROC and NIST/USA.
 2. The test was performed in EMS Room No. 1.
 3. According to IEC 61000-4-7: 2002, the time window shall be synchronized with each group of 10 or 12 cycles (200 ms) for power frequency of 50 or 60Hz.
 4. Tested Date: Feb. 26, 2020

8.4 Test Arrangement

- a. The EUT was placed on the top of a wooden table 0.8 meters above the ground and operated to produce the maximum harmonic components under normal operating conditions for each successive harmonic component in turn.
- b. The correspondent test program of test instrument to measure the current harmonics emanated from EUT is chosen. The measure time shall be not less than the time necessary for the EUT to be exercised.

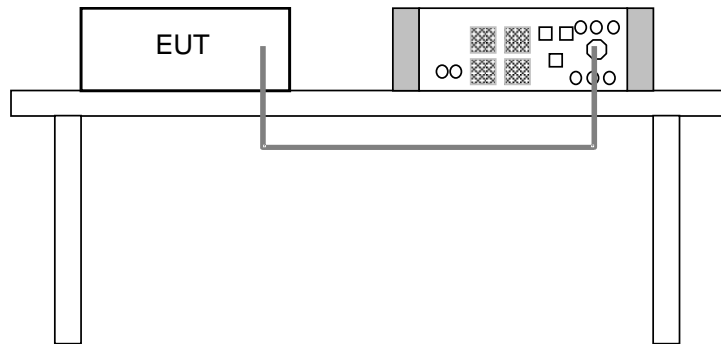

For the actual test configuration, please refer to the related item – Photographs of the Test Configuration.

8.5 Test Results

Fundamental Voltage/Ampere	230.36Vrms/ 0.307Arms	Power Frequency	50.00Hz
Power Consumption	50.9W	Power Factor	0.731
Environmental Conditions	25deg. C, 60%RH	Tested by	Kent Wang
Test Mode	Mode 1		

- Note:
1. Limits are not specified for equipment with a rated power of 75W or less (other than lighting equipment).
 2. According to EN 61000-3-2 the manufacturer shall specify the power of the apparatus. This value shall be used for establishing limits. The specified power shall be within +/-10% of the measured power.

9 Voltage Fluctuations and Flicker Measurement

9.1 Limits

Test item	Limit	Note
P_{st}	1.0	P_{st} : short-term flicker severity.
P_{lt}	0.65	P_{lt} : long-term flicker severity.
T_{max} (ms)	500	T_{max} : maximum time duration during the observation period that the voltage deviation $d(t)$ exceeds the limit for d_c .
d_{max} (%)	4	d_{max} : maximum absolute voltage change during an observation period.
d_c (%)	3.3	d_c : maximum steady state voltage change during an observation period.

9.2 Test Instruments

Description & Manufacturer	Model No.	Serial No.	Cal. Date	Cal. Due
Teseq Harmonics - Flicker Test System	Proflin 2105	32A00983 & 1639A01863	Sep. 17, 2019	Sep. 16, 2020
Software	CTS 4	NA	NA	NA

Note: 1. The calibration interval of the above test instruments is 12 months and the calibrations are traceable to NML/ROC and NIST/USA.
 2. The test was performed in EMS Room No. 1.
 3. Tested Date: Feb. 26, 2020

9.3 Test Arrangement

- The EUT was placed on the top of a wooden table 0.8 meters above the ground and operated to produce the most unfavorable sequence of voltage changes under normal operating conditions.
- During the flick measurement, the measure time shall include that part of whole operation cycle in which the EUT produce the most unfavorable sequence of voltage changes. The observation period for short-term flicker indicator is 10 minutes and the observation period for long-term flicker indicator is 2 hours.

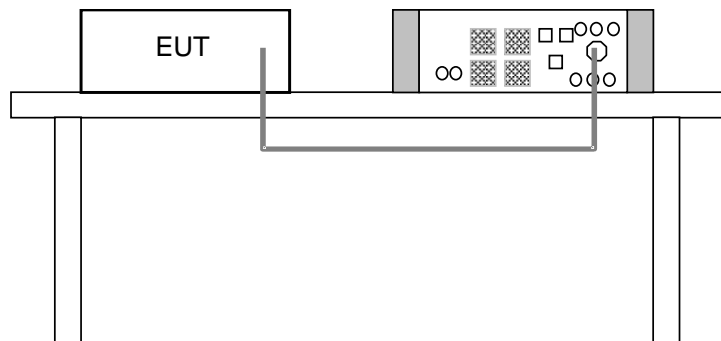

For the actual test configuration, please refer to the related item – Photographs of the Test Configuration.

9.4 Test Results

Fundamental Voltage/Ampere	230.36Vrms/ 0.307Arms	Power Frequency	50.00Hz
Observation (T _p)	10 min.	Power Factor	0.731
Environmental Conditions	25deg. C, 60%RH	Tested by	Kent Wang
Test Mode	Mode 1		

Test Parameter	Measurement Value	Limit	Remarks
P _{st}	0.156	1.00	Pass
P _{lt}	0.068	0.65	Pass
T _{max} (ms)	0	500	Pass
d _{max} (%)	0	4	Pass
d _c (%)	0	3.3	Pass

- Note: (1) P_{st} means short-term flicker indicator.
 (2) P_{lt} means long-term flicker indicator.
 (3) T_{max} means accumulated time value of d(t) with a deviation exceeding 3.3 %.
 (4) d_{max} means maximum relative voltage change.
 (5) d_c means maximum relative steady-state voltage change.

10 Electrostatic Discharge Immunity Test (ESD)

10.1 Test Specification

Basic Standard:	EN 61000-4-2
Discharge Impedance:	330 ohm / 150 pF
Discharge Voltage:	Air Discharge: $\pm 2, \pm 4, \pm 8$ kV (Direct) Contact Discharge: $\pm 2, \pm 4$ kV, ± 6 kV (Direct/Indirect)
Number of Discharge:	Minimum 20 times at each test point
Discharge Mode:	Single Discharge
Discharge Period:	1-second minimum

10.2 Test Instruments

Description & Manufacturer	Model No.	Serial No.	Cal. Date	Cal. Due
KeyTek, ESD Simulator	MZ-15/EC	0504259	Nov. 8, 2019	Nov. 7, 2020

- Note:
1. The calibration interval of the above test instruments is 12 months and the calibrations are traceable to NML/ROC and NIST/USA.
 2. The test was performed in ESD Room No. 1.
 3. Tested Date: Feb. 27, 2020

10.3 Test Arrangement

- a. Electrostatic discharges were applied only to those points and surfaces of the EUT that are accessible to users during normal operation.
- b. The test was performed with at least ten single discharges on the pre-selected points in the most sensitive polarity.
- c. The time interval between two successive single discharges was at least 1 second.
- d. The ESD generator was held perpendicularly to the surface to which the discharge was applied and the return cable was at least 0.2 meters from the EUT.
- e. Contact discharges were applied to the non-insulating coating, with the pointed tip of the generator penetrating the coating and contacting the conducting substrate.
- f. Air discharges were applied with the round discharge tip of the discharge electrode approaching the EUT as fast as possible (without causing mechanical damage) to touch the EUT. After each discharge, the ESD generator was removed from the EUT and re-triggered for a new single discharge. The test was repeated until all discharges were complete.
- g. At least ten single discharges (in the most sensitive polarity) were applied to the **Horizontal Coupling Plane** at points on each side of the EUT. The ESD generator was positioned at a distance of 0.1 meters from the EUT with the discharge electrode touching the **HCP**.
- h. At least ten single discharges (in the most sensitive polarity) were applied to the center of one vertical edge of the **Vertical Coupling Plane** in sufficiently different positions that the four faces of the EUT were completely illuminated. The **VCP** (dimensions 0.5m x 0.5m) was placed vertically to and 0.1 meters from the EUT.

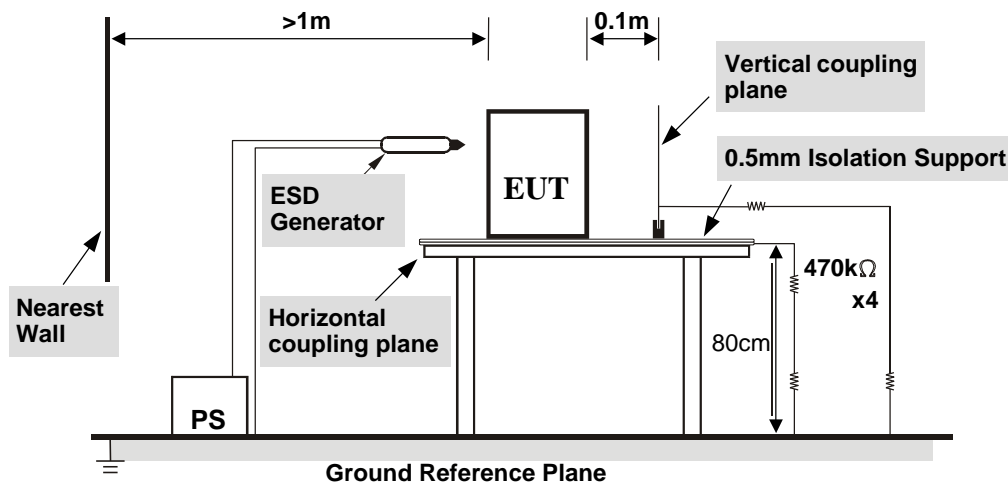

TABLE-TOP EQUIPMENT

The configuration consisted of a wooden table 0.8 meters high standing on the **Ground Reference Plane**. The **GRP** consisted of a sheet of aluminum at least 0.25mm thick, and 2.5 meters square connected to the protective grounding system. A **Horizontal Coupling Plane** (1.6m x 0.8m) was placed on the table and attached to the **GRP** by means of a cable with 940kΩ total impedance. The equipment under test, was installed in a representative system as described in section 7 of EN 61000-4-2, and its cables were placed on the **HCP** and isolated by an insulating support of 0.5mm thickness. A distance of 1-meter minimum was provided between the EUT and the walls of the laboratory and any other metallic structure.

For the actual test configuration, please refer to the related item – Photographs of the Test Configuration.

10.4 Test Results

Input Power	230 Vac, 50 Hz	Tested by	Kent Wang
Environmental Conditions	22 °C, 34% RH 1012 mbar	Test mode	Mode 1

Test Results of Direct Application

Discharge Level (kV)	Polarity (+/-)	Test Point	Contact Discharge	Air Discharge	Performance Criterion
2, 4, 6	+/-	1, 2, 3, 14	Note 1	NA	A
2, 4	+/-	4	Note 1	NA	A
6	+/-	4	Note 2	NA	B
2, 4, 8		5 ~ 9, 11, 13, 15, 16	NA	Note 1	A
2, 4	+/-	12	NA	Note 1	A
8	+/-	12	NA	Note 2	B
2, 4	+/-	10	NA	Note 1	A
8	+/-	10	NA	Note 3	B

Description of test points of direct application: Please refer to following page for representative mark only.

Test Results of Indirect Application

Discharge Level (kV)	Polarity (+/-)	Test Point	Horizontal Coupling Plane	Vertical Coupling Plane	Performance Criterion
2, 4	+/-	Four Sides	Note 1	Note 1	A
6	+/-	Four Sides	Note 2	Note 2	B

Description of test points of indirect application:

1. Front side
2. Rear side
3. Right side
4. Left side

- Note:
1. The EUT function was correct during the test.
 2. The image on the screen disappeared during the test, but self-recoverable after the test.
 3. The function of R/W delay 1~2 seconds during the test, but self-recoverable after the test.

Description of Test Points

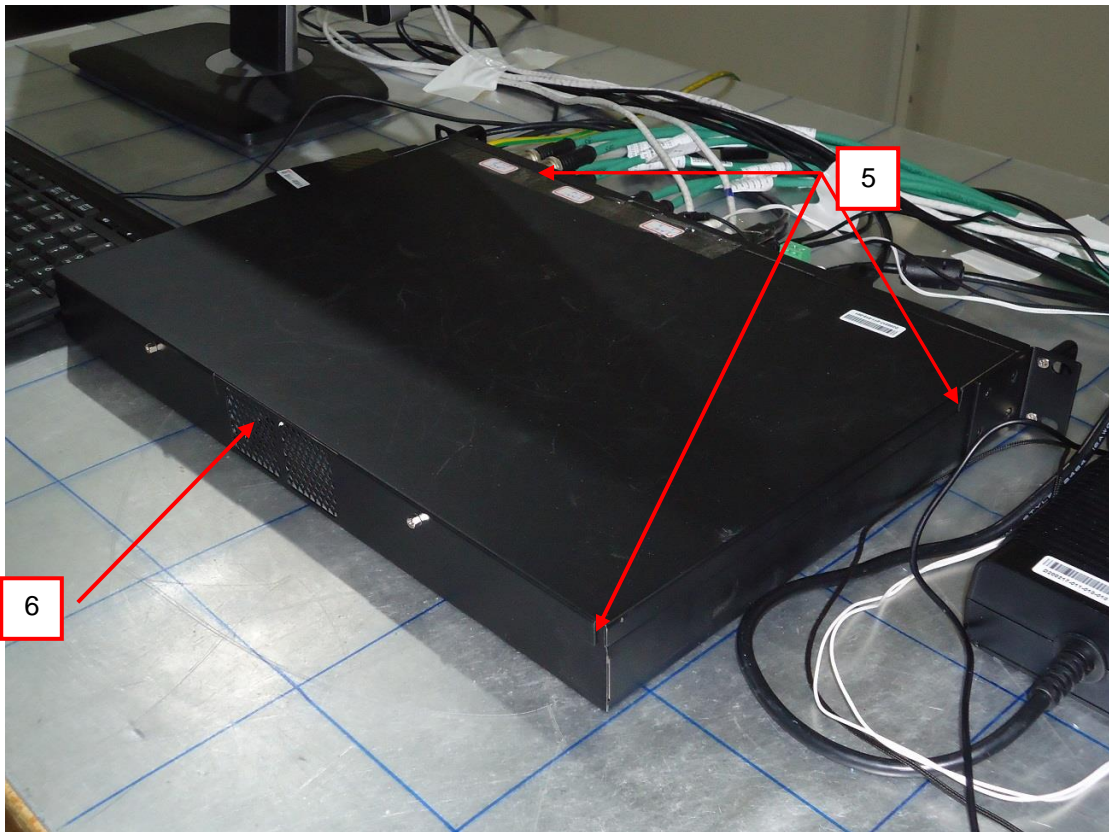
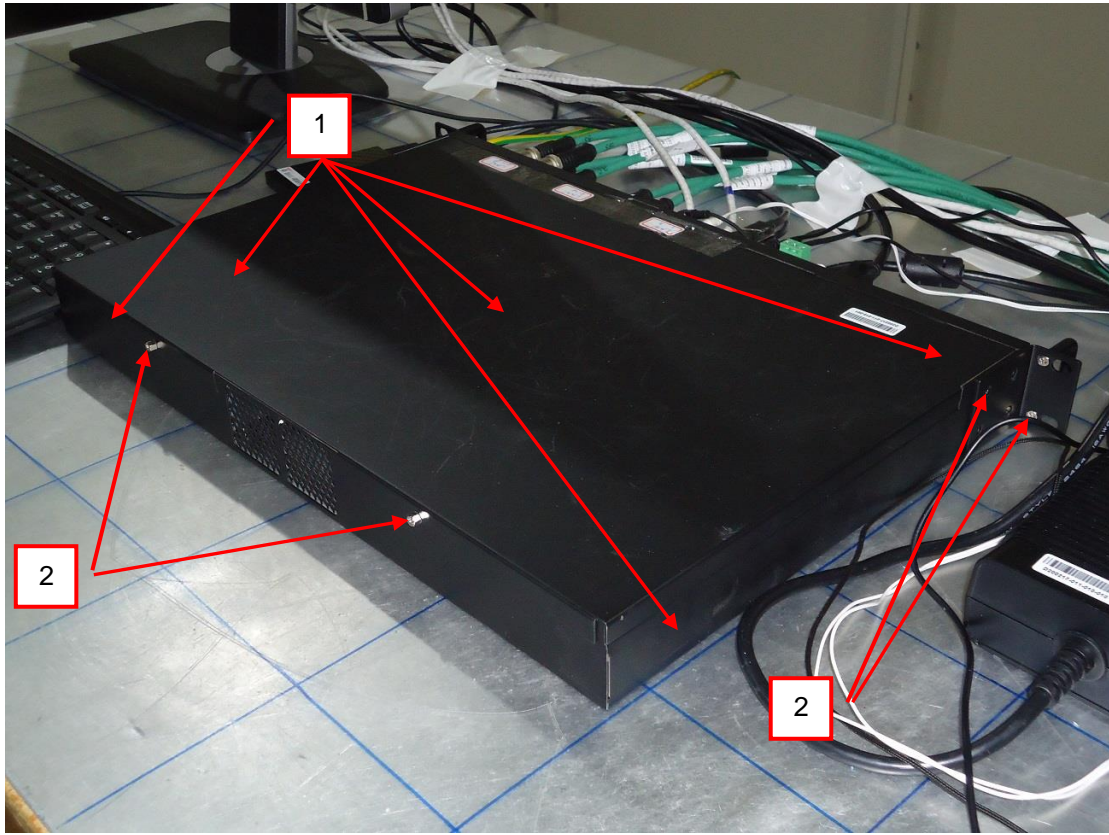

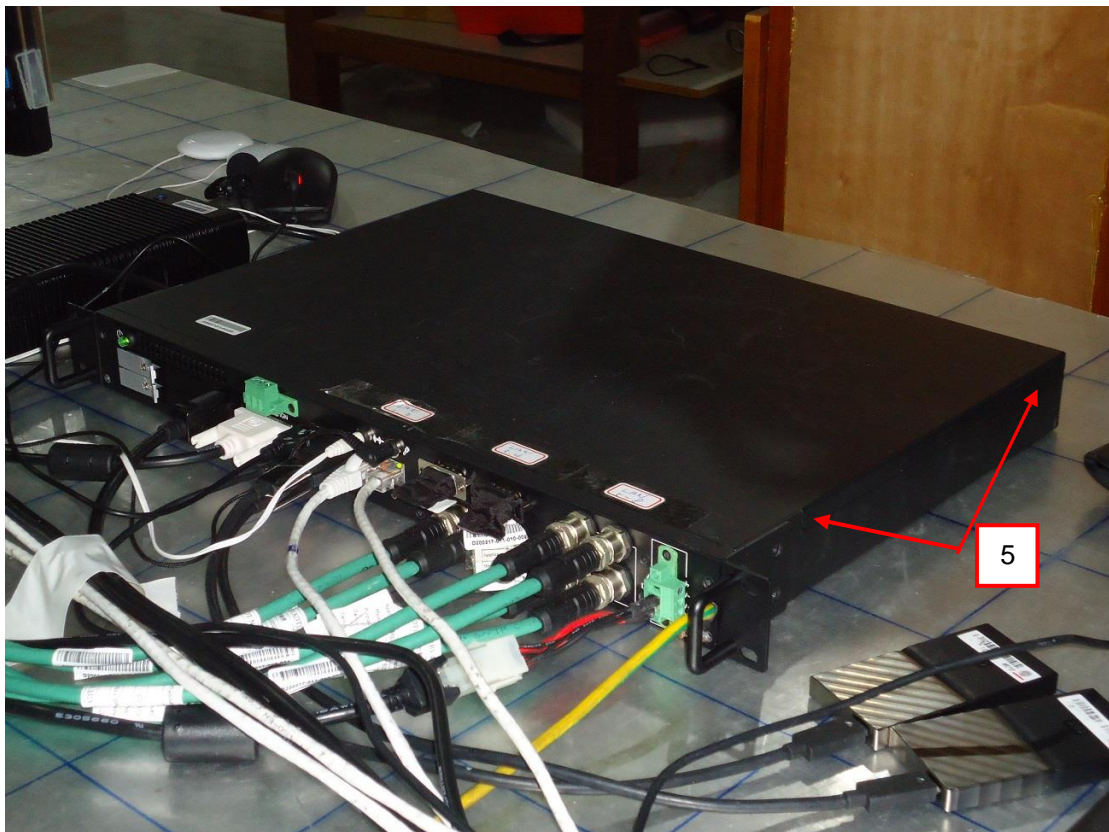
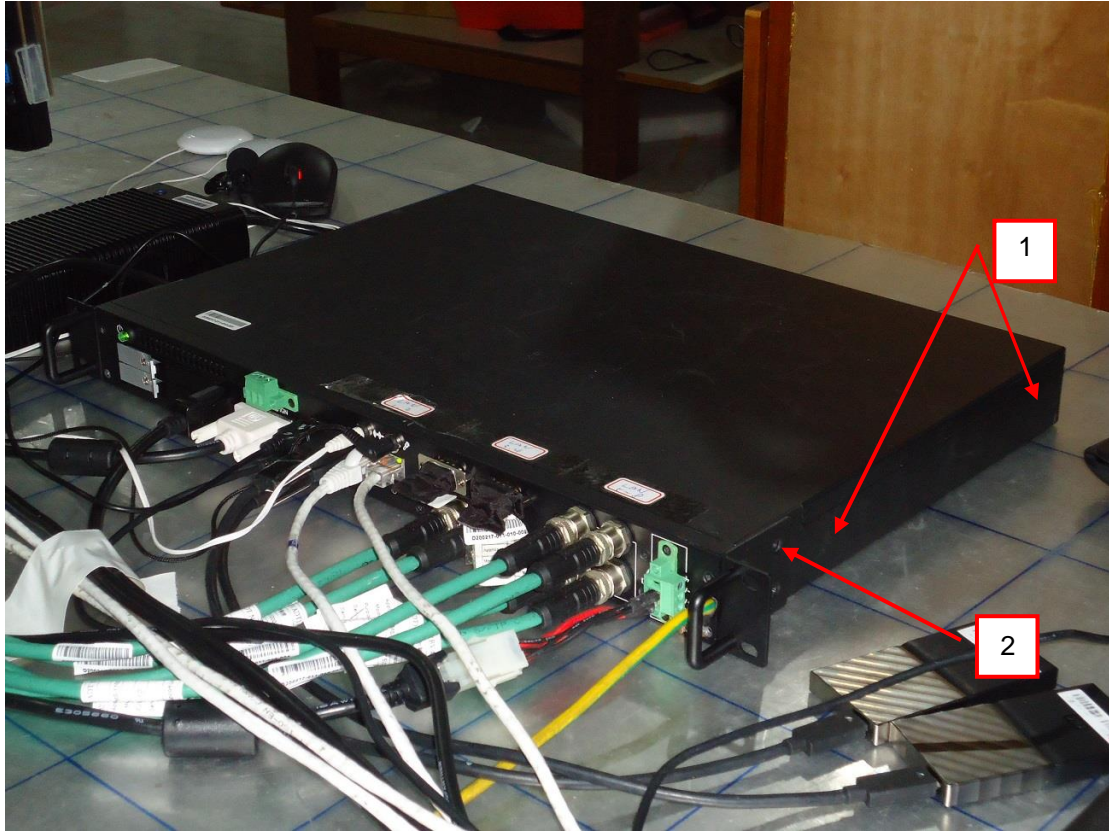

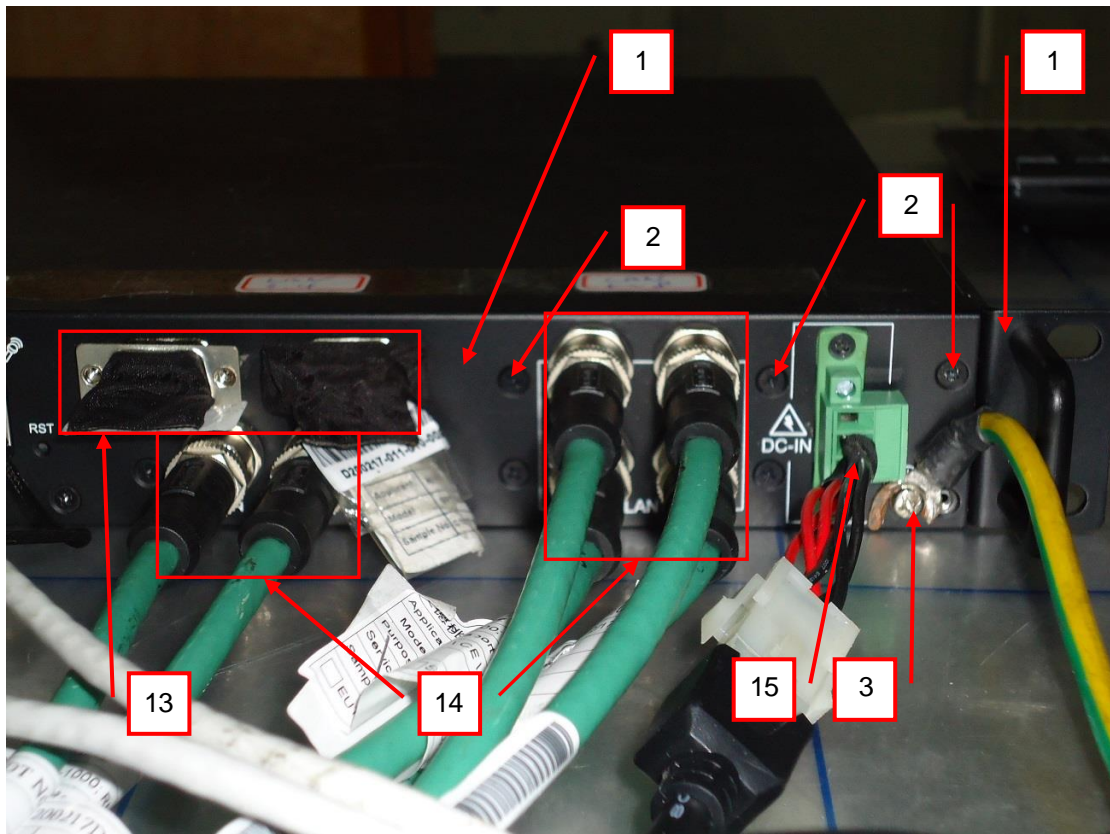
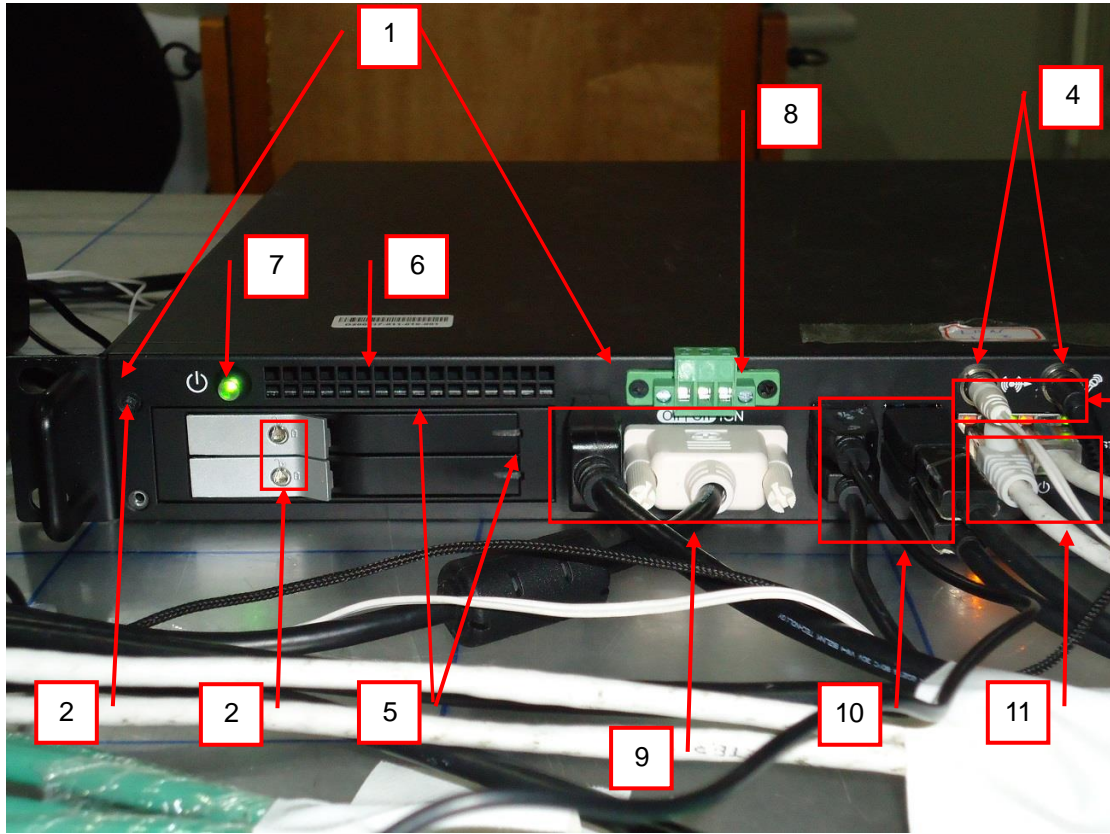

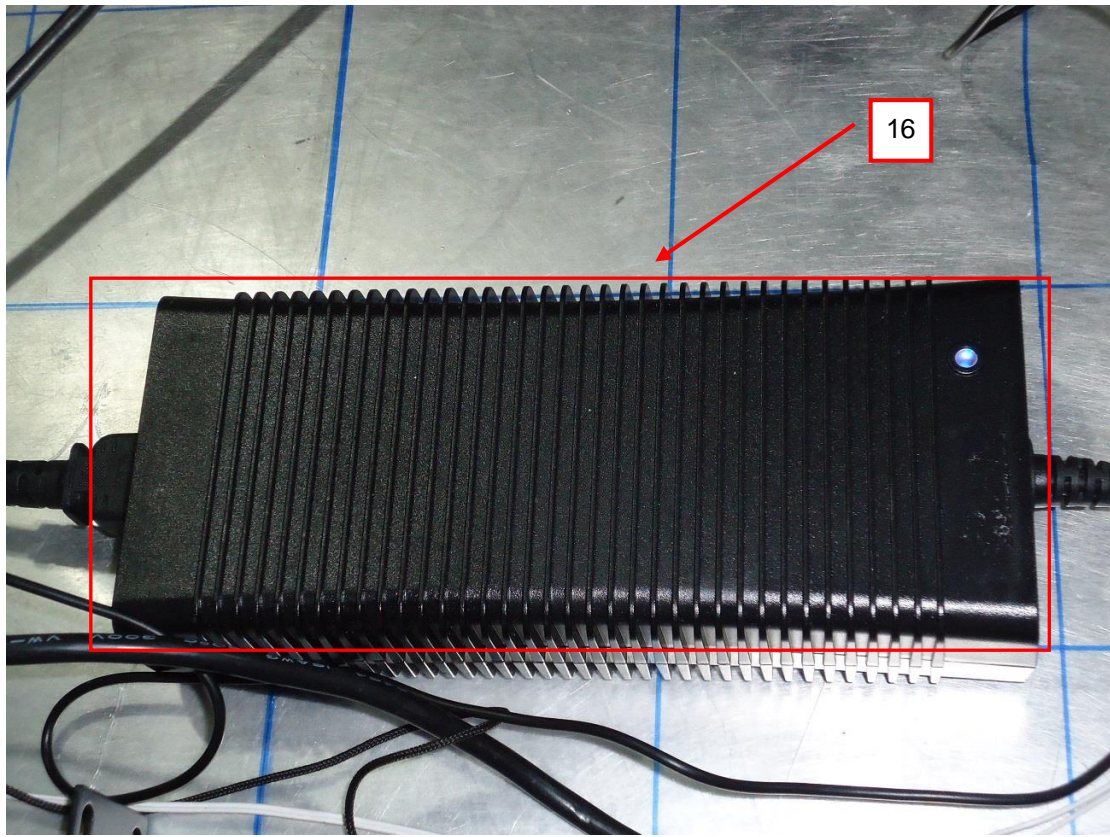

11 Radio-frequency Electromagnetic Field Immunity Test (RS)

11.1 Test Specification

Basic Standard:	EN 61000-4-3
Frequency Range, Field Strength:	80-800 MHz, 20V/m ¹
	800-1000 MHz, 20V/m
	1400-2000 MHz, 10V/m
	2000-2700 MHz, 5V/m
Modulation:	5100-6000 MHz, 3V/m
	1kHz Sine Wave, 80%, AM Modulation
Frequency Step:	1 % of preceding frequency value
Polarity of Antenna:	Horizontal and Vertical
Antenna Height:	1.5m
Dwell Time:	3 seconds

Note 1: This limit applies to equipment mounted in the passenger compartments, drivers cab or external to the rolling stock (roof, underframe). For equipment mounted in all other areas a severity level of 10 V/m may be used.

11.2 Test Instruments

Description & Manufacturer	Model No.	Serial No.	Cal. Date	Cal. Due
AgilentSignal Generator	E8257D	MY48050465	Jun. 7, 2019	Jun. 6, 2020
BONN RF Amplifier	BSA 0125-800	1912556	NA	NA
TESTQAmplifier	CBA 1G-275	T44344	NA	NA
AR RF Amplifier	35S4G8AM4	0326094	NA	NA
AR RF Amplifier	100S1G4M3	0329249	NA	NA
AR Controller	SC1000M3	305910	NA	NA
ETS Electric Field Sensor	HI-6105	00217912	Aug. 13, 2019	Aug. 12, 2020
BOONTON RF Voltage Meter	4232A	10180	May 29, 2019	May 28, 2020
BOONTON Power Sensor	51011-EMC	34152	May 29, 2019	May 28, 2020
BOONTON Power Sensor	51011-EMC	34153	May 29, 2019	May 28, 2020
ARLog-Periodic Antenna	AT6080	0329465	NA	NA
EMCO BiconiLog Antenna	3141	1001	NA	NA
ARHigh Gain Antenna	AT4010	0329800	NA	NA
SchwarzbeckLOG ANTENNA	Stlp 9149	9149-260	NA	NA
CHANCE MOST Full Anechoic Chamber (9x5x3m)	Chance Most	RS-002	Feb. 5, 2020	Feb. 4, 2021
Software	RS_V7.6	NA	NA	NA

- Note:
1. The calibration interval of the above test instruments is 12 months and the calibrations are traceable to NML/ROC and NIST/USA.
 2. The test was performed in RS Room No.2.
 3. The transmit antenna was located at a distance of 3 meters from the EUT.
 4. Tested Date: Mar. 19, 2020

11.3 Test Arrangement

The test procedure was in accordance with EN 61000-4-3.

- a. The testing was performed in a fully anechoic chamber.
- b. The frequency ranges and field strength levels are 80-800 MHz, 20V/m, 800-1000 MHz, 20V/m, 1400-2000 MHz, 10V/m, 2000-2700 MHz, 5V/m and 5100-6000 MHz, 3V/m with the signal 80% amplitude modulated with a 1kHz sine wave.
- c. The test was performed with the EUT exposed to both vertically and horizontally polarized fields on each of the four sides.

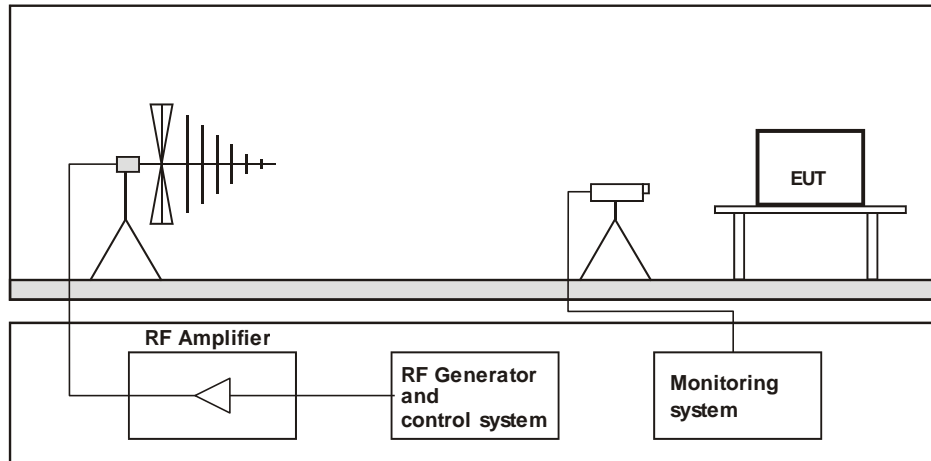

Table-top Equipment

The EUT installed in a representative system as described in section 7 of EN 61000-4-3 was placed on a non-conductive table 0.8 meters in height. The system under test was connected to the power and signal wire according to relevant installation instructions.

For the actual test configuration, please refer to the related item – Photographs of the Test Configuration.

11.4 Test Results

Input Power	230 Vac, 50 Hz	Tested by	Kent Wang
Environmental Conditions	25 °C, 75% RH	Test mode	Mode 1

Frequency (MHz)	Polarity	Azimuth(°)	Applied Field Strength		Observation	Test Distance (m)	Performance Criterion
			(V/m)	Modulation			
80 - 800	V&H	0, 90, 180, 270	20	80% AM (1kHz)	Note	1.5	A
800 - 1000	V&H	0, 90, 180, 270	20	80% AM (1kHz)	Note	1.5	A
1400 - 2000	V&H	0, 90, 180, 270	10	80% AM (1kHz)	Note	3	A
2000 - 2700	V&H	0, 90, 180, 270	5	80% AM (1kHz)	Note	3	A
5100 - 6000	V&H	0, 90, 180, 270	3	80% AM (1kHz)	Note	3	A

Note: The EUT function was correct during the test.

12 Electrical Fast Transient/Burst Immunity Test (EFT)

12.1 Test Specification

Basic Standard:	EN 61000-4-4
Test Voltage:	Signal & communication, process measurement & control ports: $\pm 2\text{kV}$, Capacitive clamp Battery referenced ports (except at the output of energy sources), Auxiliary a.c. power input ports (rated voltage $\leq 400\text{ Vrms}$): $\pm 2\text{kV}$
Impulse Repetition Frequency:	5kHz
Impulse Wave Shape:	5/50 (T_r/T_h) ns
Burst Duration:	15 ms
Burst Period:	300 ms
Test Duration:	1 min.

12.2 Test Instruments

Description & Manufacturer	Model No.	Serial No.	Cal. Date	Cal. Due
TESEQ, EFT Simulator	NSG 3060	1572	May 22, 2019	May 21, 2020
TESEQ, CDN	CDN 3083-B100	303	May 22, 2019	May 21, 2020
Haefely, Capacitive Clamp	IP4A	155173	Apr. 23, 2019	Apr. 22, 2020

- Note:
1. The calibration interval of the above test instruments is 12 months and the calibrations are traceable to NML/ROC and NIST/USA.
 2. The test was performed in EMS Room No. 2.
 3. Tested Date: Mar. 9, 2020

12.3 Test Arrangement

- Both positive and negative polarity discharges were applied.
- The distance between any coupling devices and the EUT should be 0.5 m for table-top equipment testing, and 1.0 m for floor standing equipment.
- The duration time of each test sequential was 1 minute.
- The transient/burst waveform was in accordance with EN 61000-4-4, 5/50 ns.

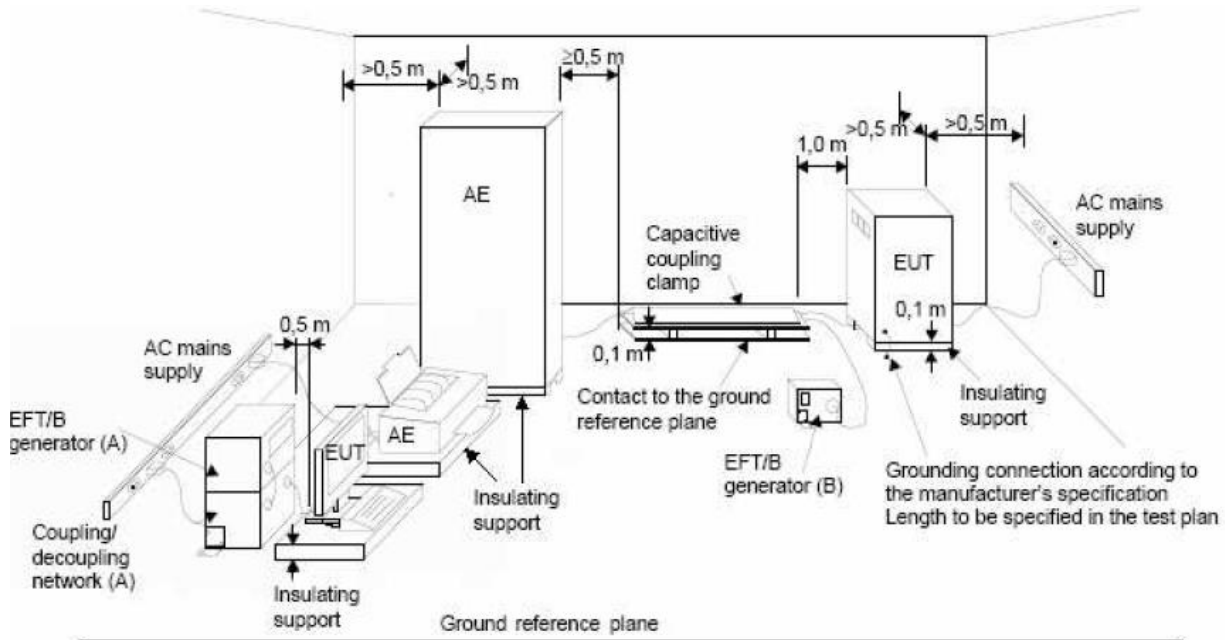

NOTE:

- location for supply line coupling
- location for signal lines coupling

For the actual test configuration, please refer to the related item – Photographs of the Test Configuration.

12.4 Test Results

Input Power	230 Vac, 50 Hz	Tested by	Thomas Cheng
Environmental Conditions	23°C, 59% RH	Test mode	Mode 1

Auxiliary a.c. power input ports (rated voltage ≤ 400 Vrms)

Voltage (kV)	Test Point	Polarity (+/-)	Observation	Performance Criterion
2	L1	+/-	Note	A
2	L2	+/-	Note	A
2	PE	+/-	Note	A
2	L1-L2-PE	+/-	Note	A

Signal & communication, process measurement & control ports

Voltage (kV)	Test Point	Polarity (+/-)	Observation	Performance Criterion
2	LAN 1	+/-	Note	A
2	LAN 2	+/-	Note	A
2	LAN 6	+/-	Note	A

Note: The EUT function was correct during the test.

13 Surge Immunity Test

13.1 Test Specification

Basic Standard:	EN 61000-4-5
Wave-Shape:	Battery referenced ports (except at the output of energy sources), Auxiliary a.c. power input ports (rated voltage ≤ 400 Vrms): 1.2/50 μ s Open Circuit Voltage 8/20 μ s Short Circuit Current
Test Voltage:	Line to line: ± 0.5 kV, ± 1 kV, Line to ground: ± 0.5 kV, ± 1 kV, ± 2 kV output impedance of 42 Ω (40 Ω and 2 Ω generator) and a coupling capacitance of 0,5 μ F
AC Phase Angle (degree):	0°, 90°, 180°, 270°
Pulse Repetition Rate:	1 time / 20 sec.
Number of Tests:	5 positive and 5 negative at selected points

13.2 Test Instruments

Description & Manufacturer	Model No.	Serial No.	Cal. Date	Cal. Due
TESEQ, Surge Simulator	NSG 3060	1572	May 22, 2019	May 21, 2020
Coupling Decoupling Network	CDN-UTP8	045	Aug. 27, 2019	Aug. 26, 2020
TESEQ Coupling Decoupling Network	CDN HSS-2	41009	May 22, 2019	May 21, 2020
TESEQ Coupling Decoupling Network	CDN 118-T8	40386	Sep. 12, 2019	Sep. 11, 2020
TESEQ CDN for Unshielded Unsymmetrical Signal & Data Lines	CDN117	40144	Sep. 12, 2019	Sep. 11, 2020

- Note:
1. The calibration interval of the above test instruments is 12 months and the calibrations are traceable to NML/ROC and NIST/USA.
 2. The test was performed in EMS Room No. 2.
 3. Tested Date: Feb. 26, 2020

13.3 Test Arrangement

The surge is to be applied to the EUT power supply terminals via the capacitive coupling network. Decoupling networks are required in order to avoid possible adverse effects on equipment not under test that may be powered by the same lines, and to provide sufficient decoupling impedance to the surge wave. The power cord between the EUT and the coupling/decoupling networks shall be 2 meters in length (or shorter).

For double-insulated products without PE or external earth connections, the test shall be done in a similar way as for grounded products but without adding any additional external grounded connections. If there are no other possible connections to earth, line-to-ground tests may be omitted.

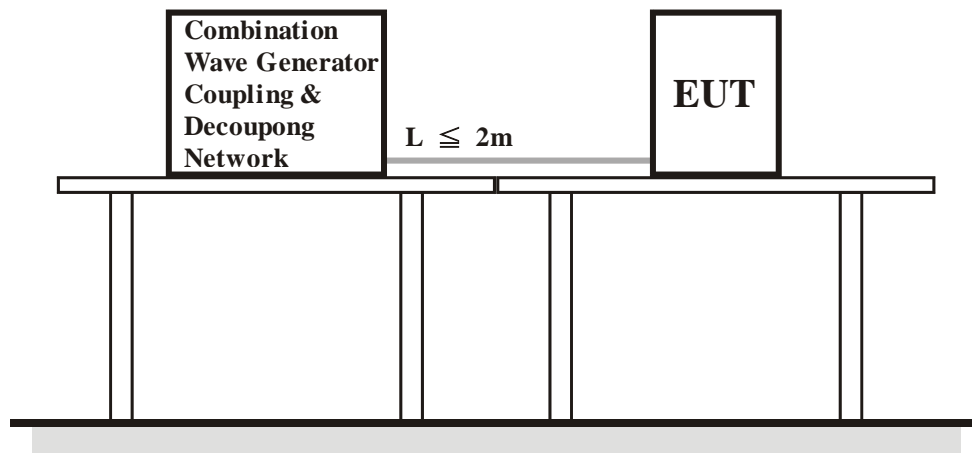

For the actual test configuration, please refer to the related item – Photographs of the Test Configuration.

13.4 Test Results

Input Power	230 Vac, 50 Hz	Tested by	Kent Wang
Environmental Conditions	23 °C, 45% RH	Test mode	Mode 1

Auxiliary a.c. power input ports (rated voltage ≤ 400 Vrms)

Voltage (kV)	Test Point	Polarity (+/-)	Observation	Performance Criterion
0.5, 1 (42 Ω + 0,5 μ F)	L1-L2	+/-	Note	A
0.5, 1, 2 (42 Ω + 0,5 μ F)	L1-PE	+/-	Note	A
0.5, 1, 2 (42 Ω + 0,5 μ F)	L2-PE	+/-	Note	A

Note: The EUT function was correct during the test.

14 Immunity to Conducted Disturbances Induced by RF Fields (CS)

14.1 Test Specification

Basic Standard:	EN 61000-4-6
Frequency Range:	0.15 MHz - 80 MHz
Voltage Level:	Battery referenced ports (except at the output of energy sources), Auxiliary a.c. power input ports (rated voltage ≤ 400 Vrms), Signal & communication, process measurement & control ports: 10 V
Modulation:	1kHz Sine Wave, 80%, AM Modulation
Frequency Step:	1 % of preceding frequency value
Dwell Time	3 seconds

14.2 Test Instruments

Description & Manufacturer	Model No.	Serial No.	Cal. Date	Cal. Due
ROHDE & SCHWARZ Signal Generator	SML03	101801	Jan. 17, 2020	Jan. 16, 2021
Digital Sweep Function Generator	8120	984801	NA	NA
AR Power Amplifier	75A250AM1	306331	NA	NA
FCC Coupling Decoupling Network	FCC-801-M2-16A	01047	Jun. 19, 2019	Jun. 18, 2020
FISCHER CUSTOM COMMUNICATIONS EM Injection Clamp	F-203I-23mm	455	NA	NA
FISCHER CUSTOM COMMUNICATIONS Current Injection Clamp	F-120-9A	361	Jul. 31, 2019	Jul. 30, 2020
B&K Ear Simulator	4185	2553594	NA	NA
EM TEST Coupling Decoupling Network	CDN M1/32A	306508	Jun. 19, 2019	Jun. 18, 2020
TESEQ Coupling Decoupling Network	CDN T800	34428	Jun. 19, 2019	Jun. 18, 2020
TESEQ Coupling Decoupling Network	CDN T800	29459	Jun. 19, 2019	Jun. 18, 2020
FCC Coupling Decoupling Network	FCC-801-T4	02031	Jun. 19, 2019	Jun. 18, 2020
EM TEST Coupling Decoupling Network	CDN T2	306509	Jun. 19, 2019	Jun. 18, 2020
R&S Power Sensor	NRV-Z5	837878/039	Nov. 8, 2019	Nov. 7, 2020
R&S Power Meter	NRVD	837794/040	Nov. 8, 2019	Nov. 7, 2020
TESEQ Coupling Decoupling Network	CDN M232	37702	Jun. 19, 2019	Jun. 18, 2020
TESEQ Coupling Decoupling Network	CDN M332	41258	Jun. 19, 2019	Jun. 18, 2020
TESEQ Coupling Decoupling Network	CDN M332	41256	Jun. 19, 2019	Jun. 18, 2020
TESEQ Coupling Decoupling Network	CDN T8-10	40376	Jun. 19, 2019	Jun. 18, 2020
TESEQ Coupling Decoupling Network	CDN S751S	35791	Mar. 5, 2019	Mar. 4, 2020
TESEQ Coupling Decoupling Network	CDN S200	53490	May 28, 2019	May 27, 2020
TESEQ Coupling Decoupling Network	CDN S400	52115	Jul. 23, 2019	Jul. 22, 2020
TESEQ Coupling Decoupling Network	ISN ST08	41212	Jun. 19, 2019	Jun. 18, 2020
FCC Coupling Decoupling Network	FCC-801-M5-50A	100018	Jan. 20, 2020	Jan. 19, 2021
Software	CS_V7.4.2	NA	NA	NA

- Note:
1. The calibration interval of the above test instruments is 12 months and the calibrations are traceable to NML/ROC and NIST/USA.
 2. The test was performed in CS Room No. 1.
 3. Tested Date: Feb. 26, 2020

14.3 Test Arrangement

- The EUT shall be tested within its intended operating and climatic conditions.
- An artificial hand was placed on the hand-held accessory and connected to the ground reference plane.
- One of the CDNs not used for injection was terminated with 50 ohm, providing only one return path. All other CDNs were coupled as decoupling networks.
- The frequency range is swept from 150 kHz to 80 MHz, using the signal level established during the setting process and with a disturbance signal of 80 % amplitude. The signal is modulated with a 1 kHz sine wave, pausing to adjust the RF signal level or the switch coupling devices as necessary. Where the frequency is swept incrementally, the step size shall not exceed 1 % of the preceding frequency value.
- Attempts should be made to fully exercise the EUT during testing, and to fully interrogate all exercise modes selected for susceptibility.

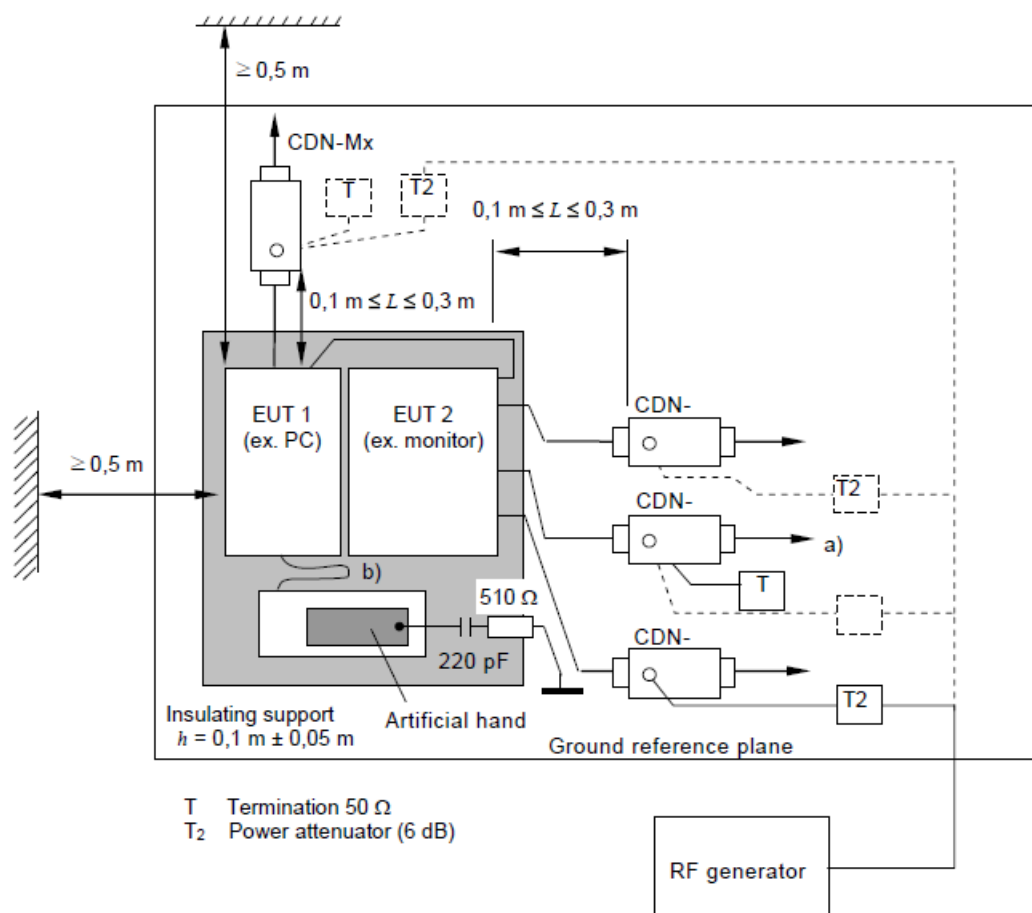

IEC 2606/13

- Note:**
- The EUT clearance from any metallic obstacles shall be at least 0,5 m.
 - Interconnecting cables (≤ 1 m) belonging to the EUT shall remain on the insulating support.
 - The equipment to be tested is placed on an insulating support of 0.1 meters height above a ground reference plane. All relevant cables shall be provided with the appropriate coupling and decoupling devices at a distance between 0.1 meters and 0.3 meters from the projected geometry of the EUT on the ground reference plane.

For the actual test configuration, please refer to the related item – Photographs of the Test Configuration.

14.4 Test Results

Input Power	230 Vac, 50 Hz	Tested by	Kent Wang
Environmental Conditions	23 °C, 75% RH	Test mode	Mode 1

Frequency (MHz)	Level (V rms)	Tested Line	Injection Method	Return Path	Observation	Remark	Performance Criterion
0.15 – 80	3	AC Power	CDN-M3	CDN-M1	Note	-	A
0.15 – 80	3	LAN 1	CDN-T8	CDN-M1	Note	-	A
0.15 – 80	3	LAN 2	CDN-T8	CDN-M1	Note	-	A
0.15 – 80	3	LAN 6	CDN-T8-10	CDN-M1	Note	-	A

Note: The EUT function was correct during the test.

15 Pictures of Test Arrangements

15.1 Conducted Disturbance at Auxiliary a.c. or d.c. power ports

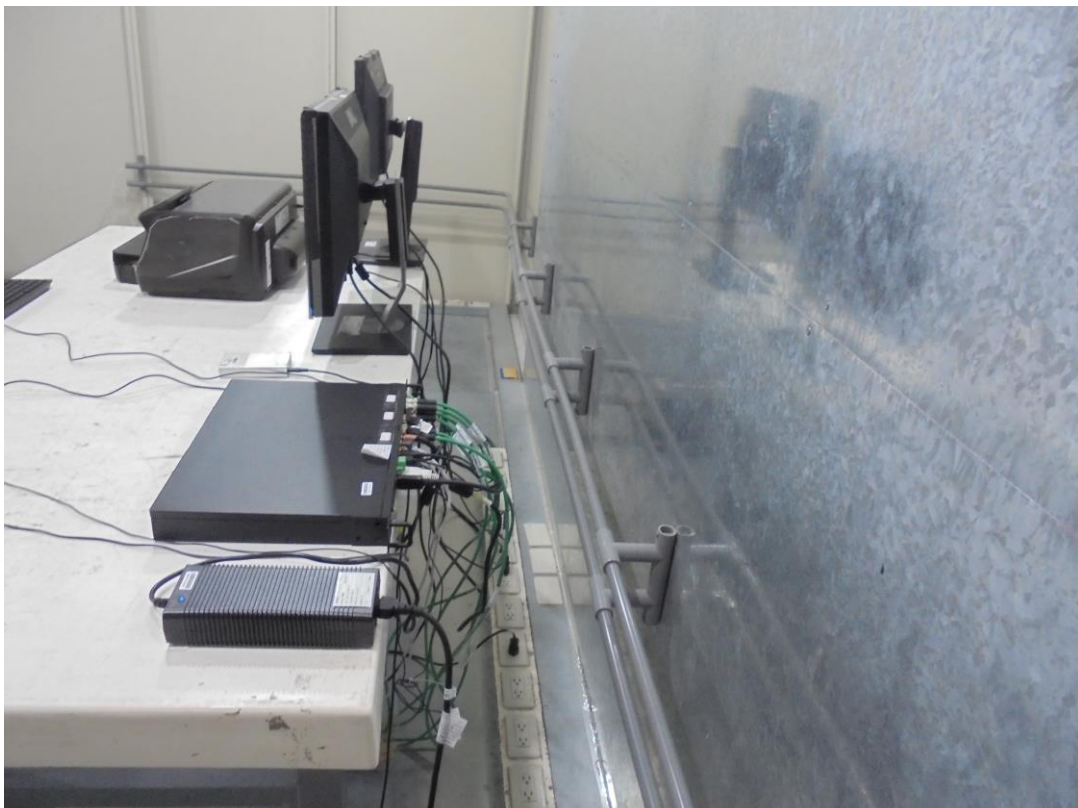

15.2 Radiated Disturbance up to 1 GHz



15.3 Radiated Disturbance above 1 GHz

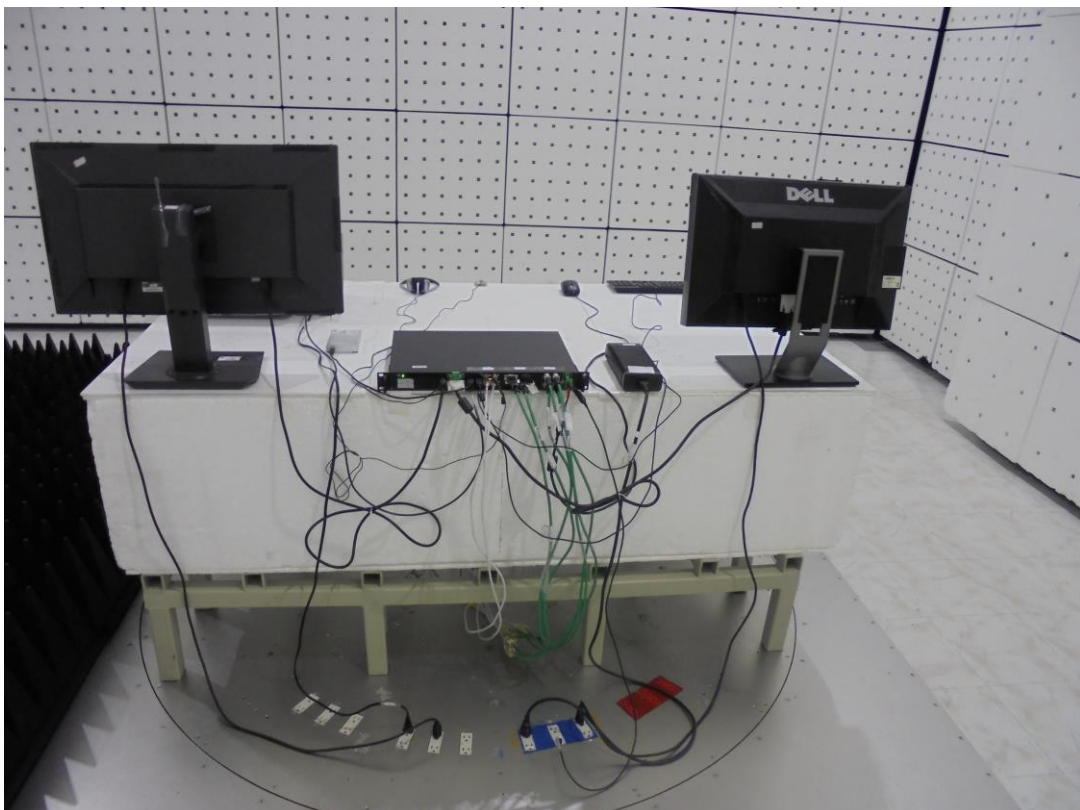

15.4 Harmonics Current, Voltage Fluctuations and Flicker Measurement



15.5 Electrostatic Discharge Immunity Test (ESD)

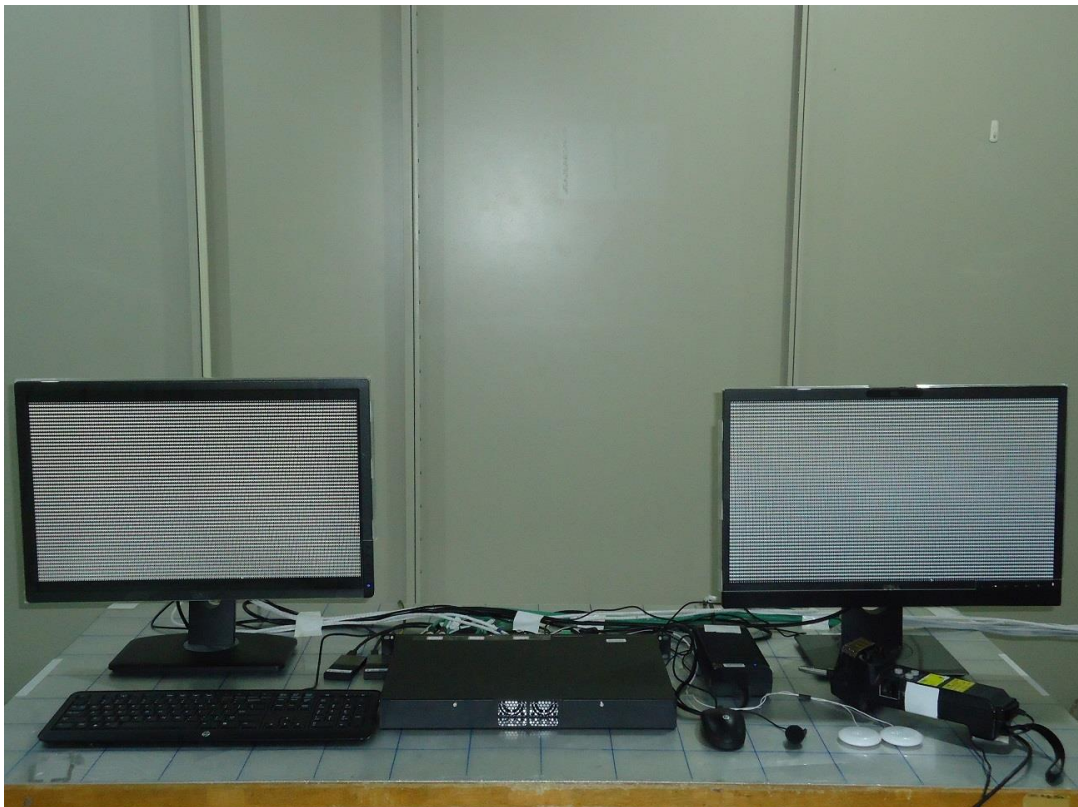

15.6 Radio-frequency Electromagnetic Field Immunity Test (RS)



15.7 Fast Transients (EFT)

Mains ports



LAN 1



LAN 2



LAN 6



15.8 Surge

Mains ports



15.9 Radio-frequency common mode (CS)

Mains ports

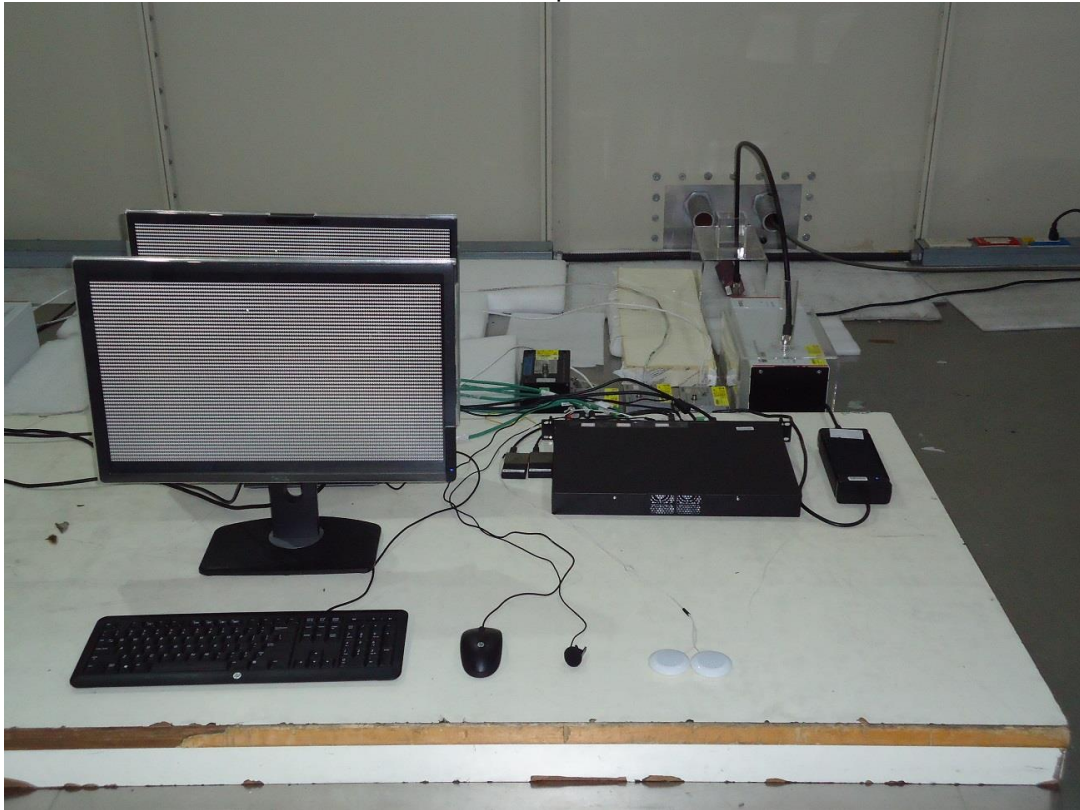

LAN 1



LAN 2

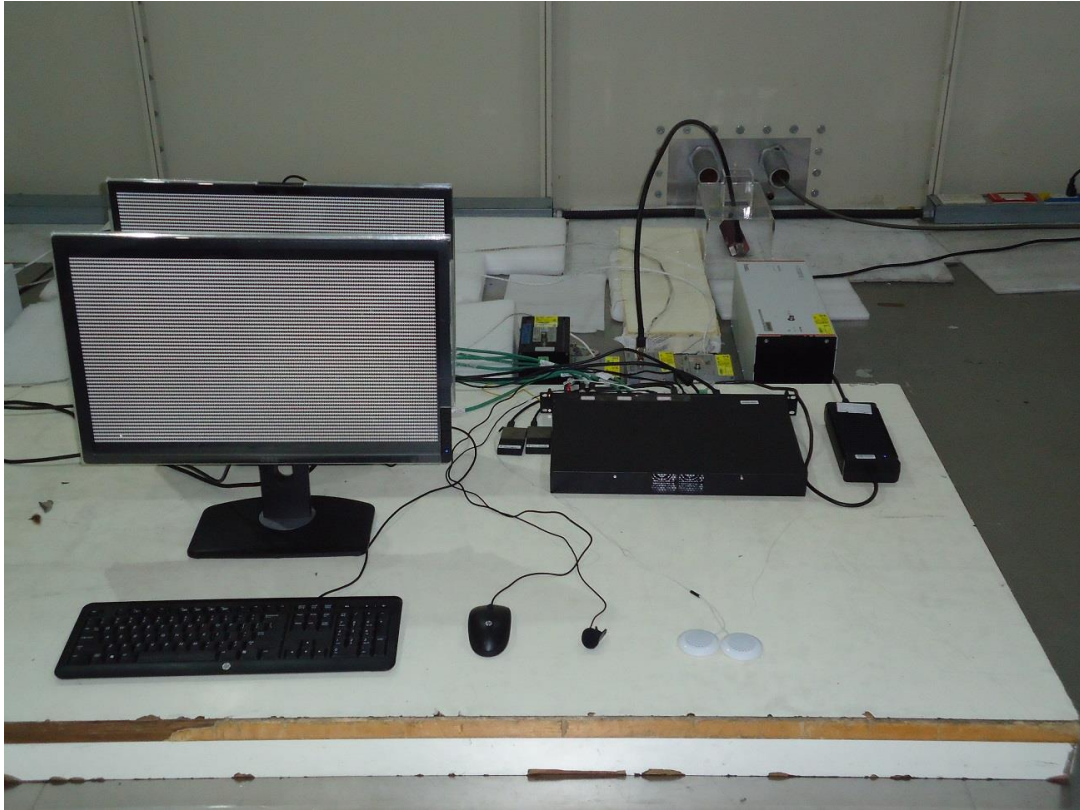

LAN 6

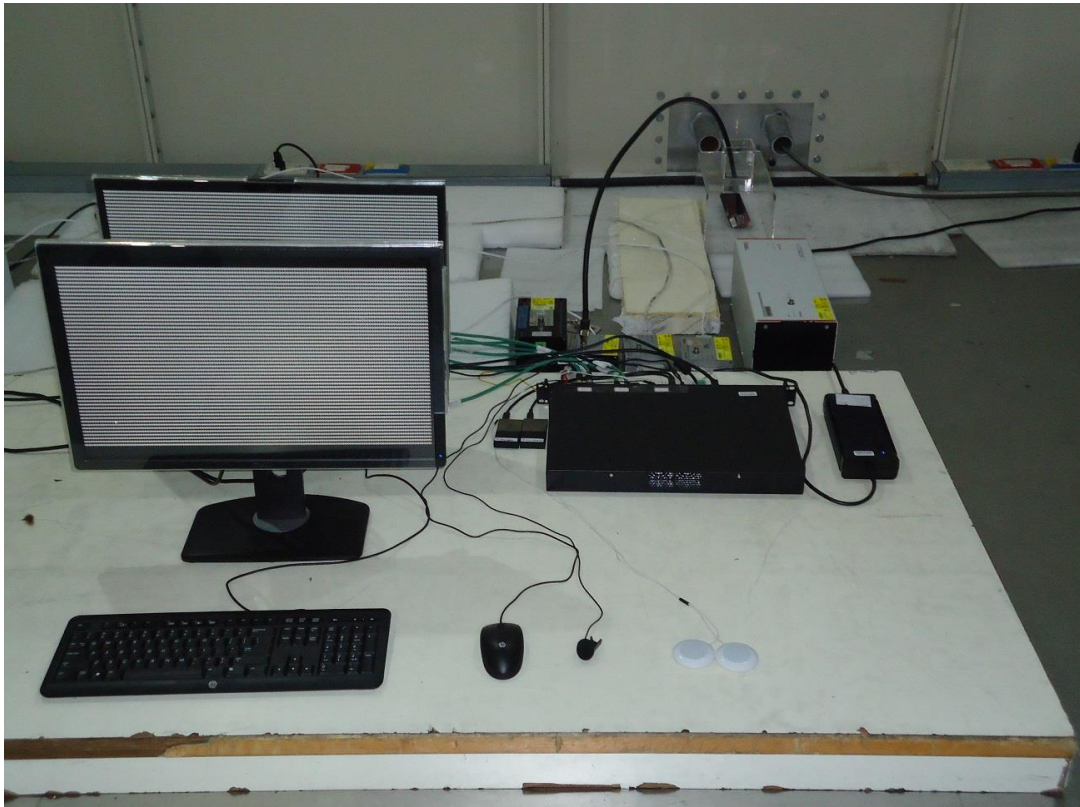

Appendix – Information of the Testing Laboratories

We, Bureau Veritas Consumer Products Services (H.K.) Ltd., Taoyuan Branch, were founded in 1988 to provide our best service in EMC, Radio, Telecom and Safety consultation. Our laboratories are accredited and approved according to ISO/IEC 17025.

If you have any comments, please feel free to contact us at the following:

Lin Kou EMC/RF Lab

Tel: 886-2-26052180

Fax: 886-2-26051924

Hsin Chu EMC/RF/Telecom Lab

Tel: 886-3-6668565

Fax: 886-3-6668323

Hwa Ya EMC/RF/Safety Lab

Tel: 886-3-3183232

Fax: 886-3-3270892

Email: service.adt@tw.bureauveritas.com

Web Site: www.bureauveritas-adt.com

The address and road map of all our labs can be found in our web site also.

--- END ---